

Memorandum to the City of Markham Committee of Adjustment

May 22nd, 2019

File: A/39/19
Address: 20 Stone Jug Avenue, Markham
Applicant: Adrian Leandro
Agent: Cindy McPhee
Hearing Date: Wednesday May 29th, 2019

The following comments are provided on behalf of the East Team:

The applicant is requesting relief from the following requirements of By-law 177-96, as amended, to permit:

- a) **Section 7.432.2(b):**
a minimum setback of 4.0 m for a detached private garage from the main building on the lot, whereas the By-law requires a minimum setback of 5.0m;
- b) **Section 6.3.1.7(b):**
a maximum lot coverage of 19.5 percent for a detached garage that is accessed by a lane, whereas the By-law permits a maximum lot coverage of 18 percent; and
- c) **Parking By-law 28-97, Section 3:**
Zero (0) parking space for the accessory dwelling unit, whereas the By-law requires one (1) parking space for an accessory unit.

These variances relate to a proposed coach house (accessory dwelling unit) located above an existing detached garage on the subject property (20 Stone Jug Avenue).

BACKGROUND

Property Description

The 238.30 m² (2,565.04 ft²) subject property is located on the north side of Stone Jug Avenue, which is south of White's Hill Avenue and west of Cornell Centre Boulevard in the Cornell community. The property is located within a low rise residential neighbourhood comprised of lane-based townhouse, detached and semi-detached dwellings. There is an existing two-storey 167.64 m² (1,804.46 ft²) townhouse dwelling on the subject property which according to assessment records was constructed in 2015. Vehicle access is located at the rear lane, with two required parking spaces within the existing detached private garage. The proposed site plan is attached as Appendix 'A'.

Proposal

The applicant is proposing a second-storey coach house (accessory dwelling unit) addition above the existing detached garage at the rear of the subject property. The coach house will be accessed by enclosed stairs around the east yard and south side of the garage. This will expand the footprint of the existing garage and reduce its separation to the main townhouse dwelling. The increased coverage and reduced setback variances are requested to facilitate this proposal. Insufficient space exists on the subject site to provide additional parking, and the applicant is also requesting a parking variance to facilitate the coach house.

Official Plan and Zoning

Official Plan 2014 (partially approved on Nov 24/17, and further updated on April 9/18)

The subject property is designated "Residential Low Rise", which provides for low rise housing forms including townhouse dwellings. Section 8.2.3.5 of the 2014 Official Plan outlines development criteria for the 'Residential Low Rise' designation with respect to height, massing and setbacks. This criteria is established to ensure that development is appropriate for the site and generally consistent with the zoning requirements for adjacent properties. In considering applications for development approval in a 'Residential Low Rise' area, including variances, infill development is required to meet the general intent of these development criteria.

Zoning By-Law 177-96

The subject property is zoned 'Residential Two *190*432*465 (R2*190*432*465) under By-law 177-96, as amended, which permits townhouse dwellings.

Exception *190 provides area specific zone standards which includes permission of accessory dwellings located above a private garage in either the main building or an accessory building on the same lot (i.e. above an attached or detached garage).

Exception *432 permits townhouse dwellings as the only permitted use and provides area specific zone standards that permits:

- an accessory dwelling above a private garage;
- a minimum rear yard setback of 0.6 m;
- a minimum setback of 5.0 m between a private garage and main building on a lot; and
- attached private garages subject to other criteria within the by-law.

Exception *465 provides special site provisions for porch encroachments. Given that the proposal does not propose modifications to the existing porch, exception *465 is not applicable in the context of assessing the variance application.

Parking Standards By-law 28-97

Parking Standards By-law 28-97, as amended, requires two parking spaces for the townhouse unit and an additional parking space for the proposed accessory unit in the form of a coach house above the garage. Since no changes are proposed to the onsite-parking configuration, the applicant is requesting a variance to allow the accessory unit without requiring parking for it. Further details are provided in the comment section below.

Applicant's Stated Reason(s) for Not Complying with Zoning

Please see Appendix 'B'.

Zoning Preliminary Review (ZPR) Undertaken

The applicant completed a Zoning Preliminary Review (ZPR) to confirm the variances initially requested. The original submission proposed that the stairs to the coach house would expand the entire width of the garage in the rear yard. Consequently the reduced setback to the main dwelling applied to the entire garage/coach house building. Additionally, the garage/coach house building initially had a proposed lot coverage of approximately 20.9%.

Planning staff had concerns that the proposed 2nd storey coach house addition was too close to the adjacent dwelling unit to the west (18 Stone Jug Lane) and requested that the applicant consider options to mitigate its visual impact. The applicant submitted revised plans on May 22nd,

2019 where the stairs are within a portion of the rear yard, as shown in Appendix A. The applicant completed a second ZPR to confirm the variances required for revised plans.

COMMENTS

The Planning Act states that four tests must be met in order for a variance to be granted by the Committee of Adjustment:

- a) The variance must be minor in nature;
- b) The variance must be desirable, in the opinion of the Committee of Adjustment, for the appropriate development or use of land, building or structure;
- c) The general intent and purpose of the Zoning By-law must be maintained;
- d) The general intent and purpose of the Official Plan must be maintained.

Reduction in Detached Garage Setback

The applicant is requesting a minimum 4.0 m (13.12 ft) setback for the detached private garage from the main dwelling on a lot, whereas the by-law requires a minimum setback of 5.0 m (16.40 ft). Staff note that the minimum 5.0 m setback is an area specific development standard permitted through Exception*432. Typically By-law 177-96, as amended, requires a minimum setback of 6.0 m for detached garages from the main building on a lot.

As noted, staff had concerns with the original proposal, where the 2nd storey coach house addition expanded the entire width of the garage. The applicant revised their plans by removing a portion of the 2nd storey addition within proximity of this adjacent dwelling to lessen its visual impact. Consequently the 1.0 m setback reduction only applies to a 2.91 m (9.55 ft) wide portion of the 2nd storey coach house addition that will not impact abutting properties. Staff are of that this variance request meets the four tests of the Planning Act.

Increase in Maximum Lot Coverage

The applicant is requesting relief for a maximum lot coverage of 19.5 percent, whereas the By-law permits a maximum lot coverage of 18 percent. The proposed lot coverage includes a staircase and space for utilities which adds approximate 6.53 m² (70.3 ft²) to the overall building footprint. Staff are of the opinion that the increase in lot coverage will not significantly add to the scale and massing of the dwelling.

Reduced Parking Spaces

As noted, Parking Standards By-law 28-97 requires two parking spaces for the townhouse dwelling unit and an additional space for the proposed accessory coach house unit or secondary suite. The existing double-car garage currently provides two parking spaces.

The existing property does not have sufficient space to provide an additional parking space to comply with the Parking By-law. Requiring an additional parking space on the subject property will create a precedent that may have citywide impacts. Staff do not have concerns with the requested variance to reduce parking for the accessory coach house dwelling unit.

Staff are also of the opinion that the parking issue may be considered “self-regulating”, as the unit would only be of interest to a tenant that does not require a parking space, in the event that both parking spaces are required for use by the owner of the dwelling. The applicant should be aware that no overnight parking is permitted on City of Markham public streets unless an overnight parking pass or exemption is obtained through the By-law and Licensing Department.

PUBLIC INPUT SUMMARY

No written submissions were received as of May 22nd, 2019. It is noted that additional information may be received after the writing of the report, and the Secretary-Treasurer will provide information on this at the meeting.

CONCLUSION

Planning Staff have reviewed the application with respect to Section 45(1) of The Planning Act, R.S.O. 1990, c. P.13, as amended, and are of the opinion that the variance request meets the four tests of the Planning Act. Staff recommend that the Committee consider public input in reaching a decision.

The onus is ultimately on the applicant to demonstrate why they should be granted relief from the requirements of the zoning by-law, and how they satisfy the tests of the Planning Act required for the granting of minor variances.

Please see Appendix "C" for conditions to be attached to any approval of this application.

PREPARED BY:



Aqsa Malik, Planner, Zoning and Special Projects

REVIEWED BY:



Stephen Corr, Senior Planner, East District
File Path: Amanda\File\ 19 118350 \Documents\District Team Comments Memo

This Site Plan is based on a Plan prepared by
 KRCMAR Surveyors LTD.
 ONTARIO LAND SURVEYORS
 SIGNED BY MICHAEL MCKECHNIE
 dated MAY 23, 2014

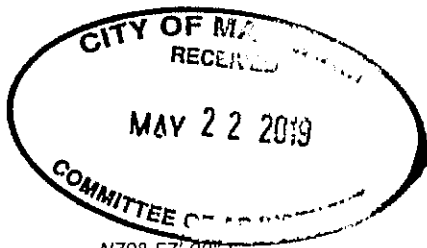

1 SITE PLAN
 Scale: 1:100

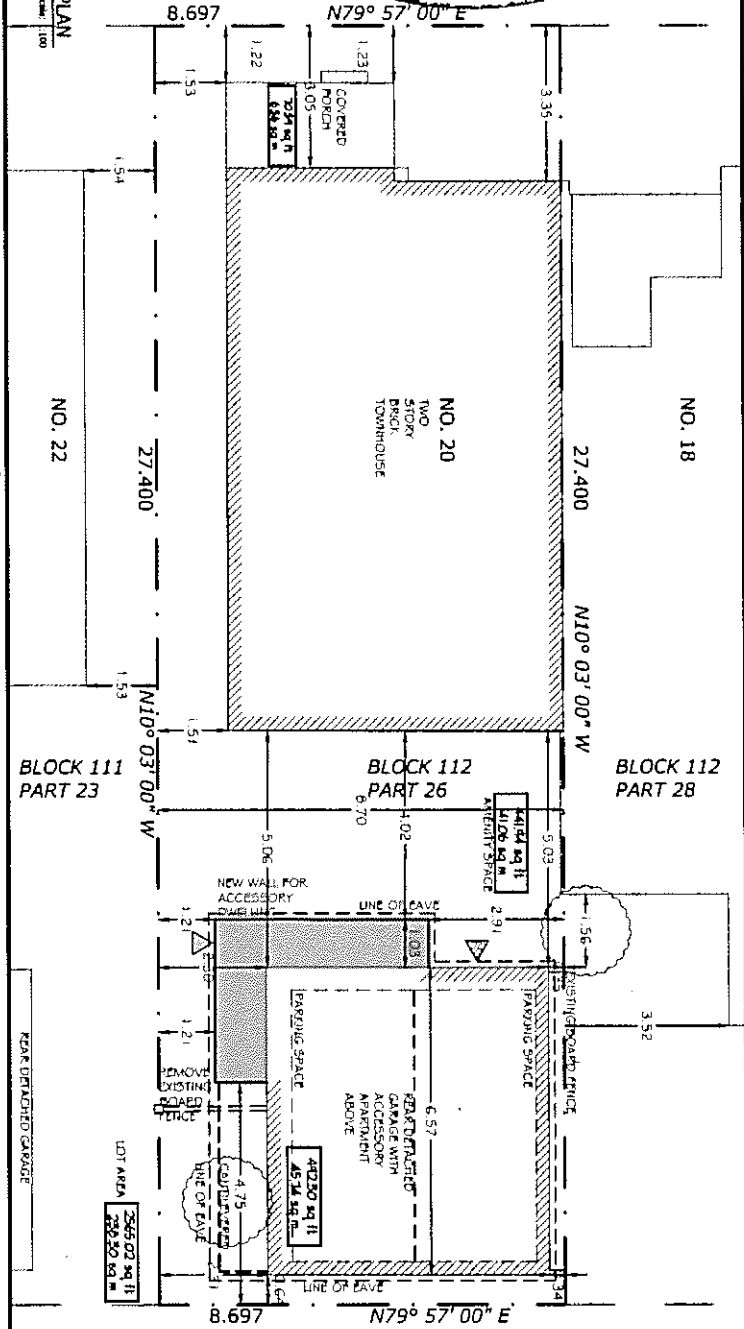

2 SITE STATISTICS

City of Markham Zoning By-law 177-06
 PROPOSAL FOR A SECONDARY DWELLING LOCATED ABOVE DETACHED REAR LANE GARAGE
 Rpt 1007437466

LOT AREA:	239.30 m ²
LOT COVERAGE	
TOWNHOUSE AREA	46.69 m ² EXISTING TO REMAIN
NEW GARAGE AREA	48.50 m ² NEW AREA
COVERED PORCH AREA	8.56 m ² EXISTING TO REMAIN
NEW AMENITY AREA AT REAR YARD	41.09 m ²
SETBACKS:	PROPOSED
NORTH (LANE) YARD	0.84 m EXISTING TO REMAIN
EAST SIDE YARD	1.21 m
WEST SIDE YARD	0.34 m EXISTING TO REMAIN
SOUTH SIDE DISTANCE TO HOUSE	4.02 m
PARKING SPACE BESIDE GARAGE	2.31 m x 6.83 m
PROPOSED HEIGHT OF NEW REAR COACH HOUSE	8.69 m

NORTH:

ALL DIMENSIONS IN METERS AND DECIMALS THEREOF SHALL BE TO CENTERLINE UNLESS OTHERWISE NOTED. THE DRAWING IS FOR INFORMATION ONLY AND SHALL NOT BE USED FOR CONSTRUCTION WITHOUT THE SIGNATURE OF THE ENGINEER. THE ENGINEER'S RESPONSIBILITY IS LIMITED TO THE DESIGN AND CONSTRUCTION OF THE DRAWING. THE ENGINEER IS NOT RESPONSIBLE FOR THE ACCURACY OF ANY INFORMATION PROVIDED BY OTHER SOURCES. THE ENGINEER'S OFFICE SHALL BE CONSULTED FOR ANY CHANGES TO THE DRAWING. THE ENGINEER'S OFFICE SHALL BE CONSULTED FOR ANY CHANGES TO THE DRAWING. THE ENGINEER'S OFFICE SHALL BE CONSULTED FOR ANY CHANGES TO THE DRAWING.

NO.	DATE	DESCRIPTION
1	2018	ISSUED FOR REVIEW
2	2018	ISSUED FOR REVIEW
3	2019	ISSUED FOR REVIEW
4	2019	ISSUED FOR REVIEW
5	2019	ISSUED FOR REVIEW

REVISIONS

PROJECT ADDRESS:
 20 STONE BEAR LANE
 MARKHAM, ON

PROJECT NUMBER: 1837

DRAWN BY: OR

DATE: DEC 2018

SCALE: E1:100

DRAWING NUMBER: A-1.0

www.thestepdesign.ca
 416-774-9177

Step Design
 1837
 416-774-9177

1
SECOND FLOOR PLAN
 Scale: 1/4" = 1'-0"
 DATE: 11/14/2018
 DRAWN BY: J. L. ...
 CHECKED BY: ...
 PROJECT NO.: ...

20 STONE JUG AVE.
 MARKHAM, ON

53205 sq. ft.
 4943 sq. m.

MAY 21, 2018
 JUN 14, 2018
 DEC. 12, 2018
SECOND FLOOR PLAN
A-2.3

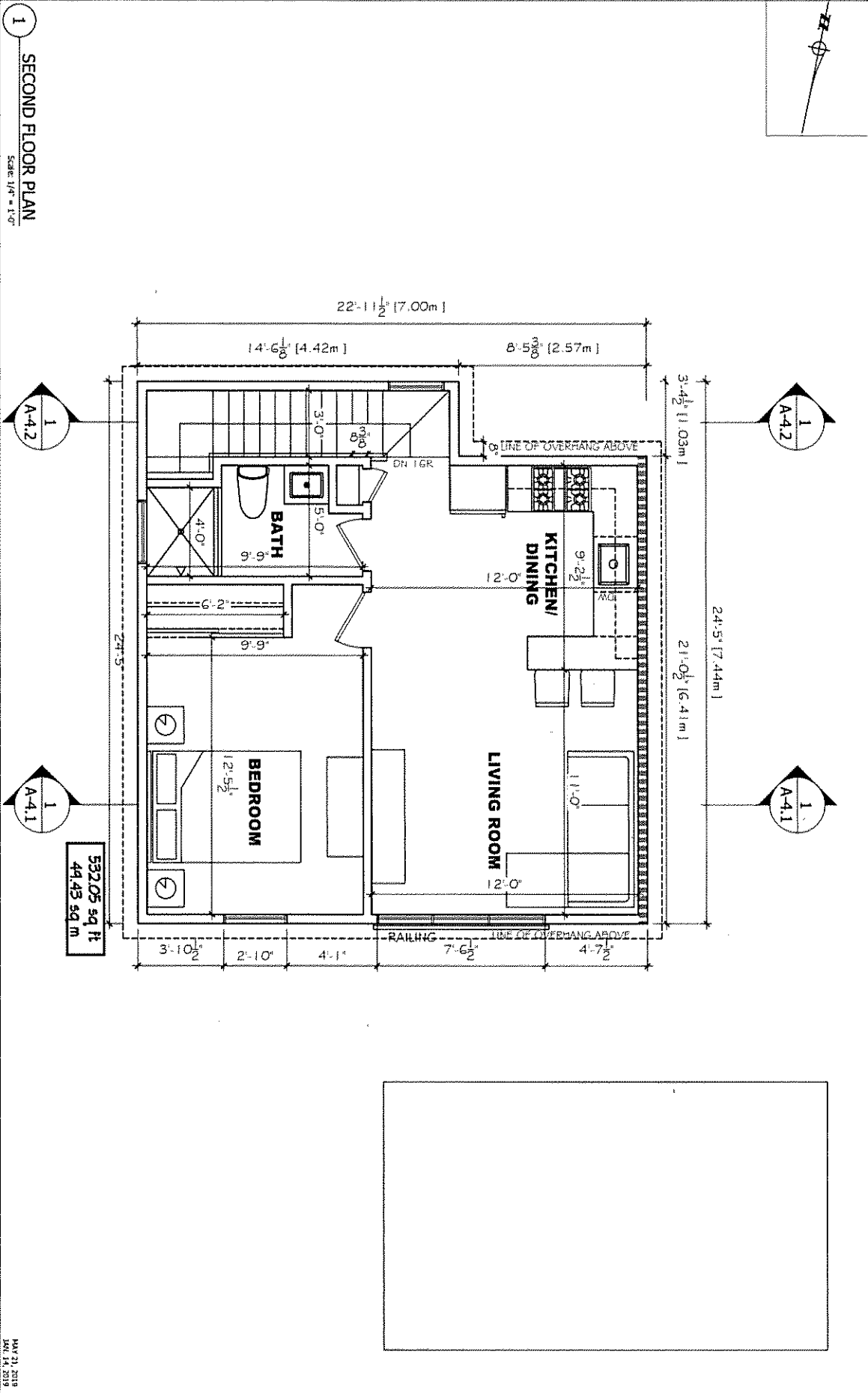



1 ROOF PLAN

Scale: 1/4" = 1'-0"

116-278-8278
www.thetrustcorp.com

20 STONE JUG AVE.
MARKHAM, ON

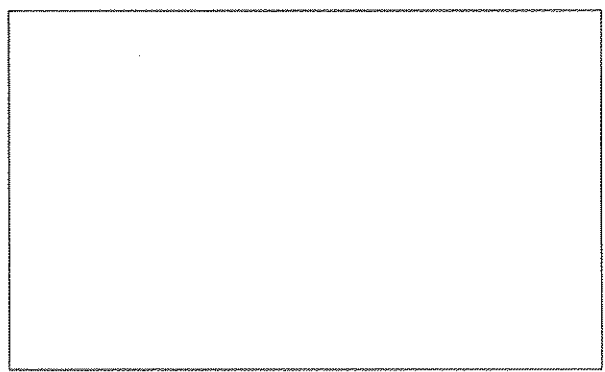
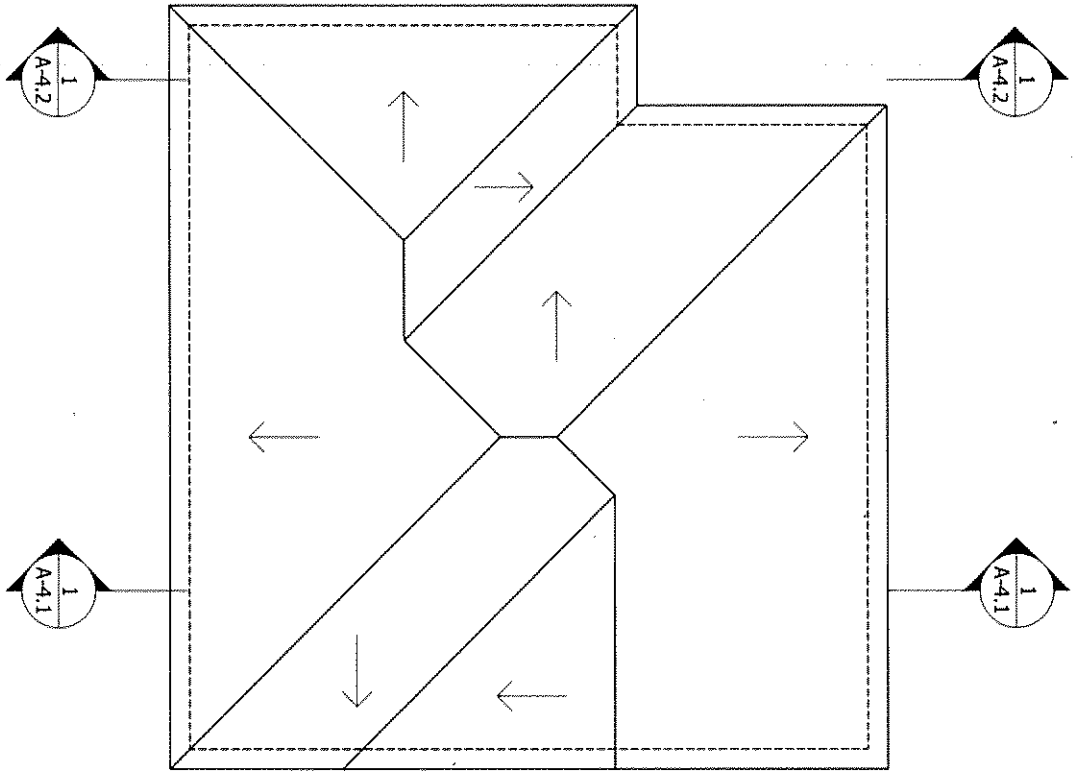

ROOF PLAN
MAY 21, 2019
A-2.4

20 STONE JUG AVE.
 MARKHAM, ON

NEW ELEVATIONS
 DEC. 12, 2018

JAN. 14, 2019
A-3.1

1 NORTH ELEVATION
 Scale: 1/4" = 1'-0"

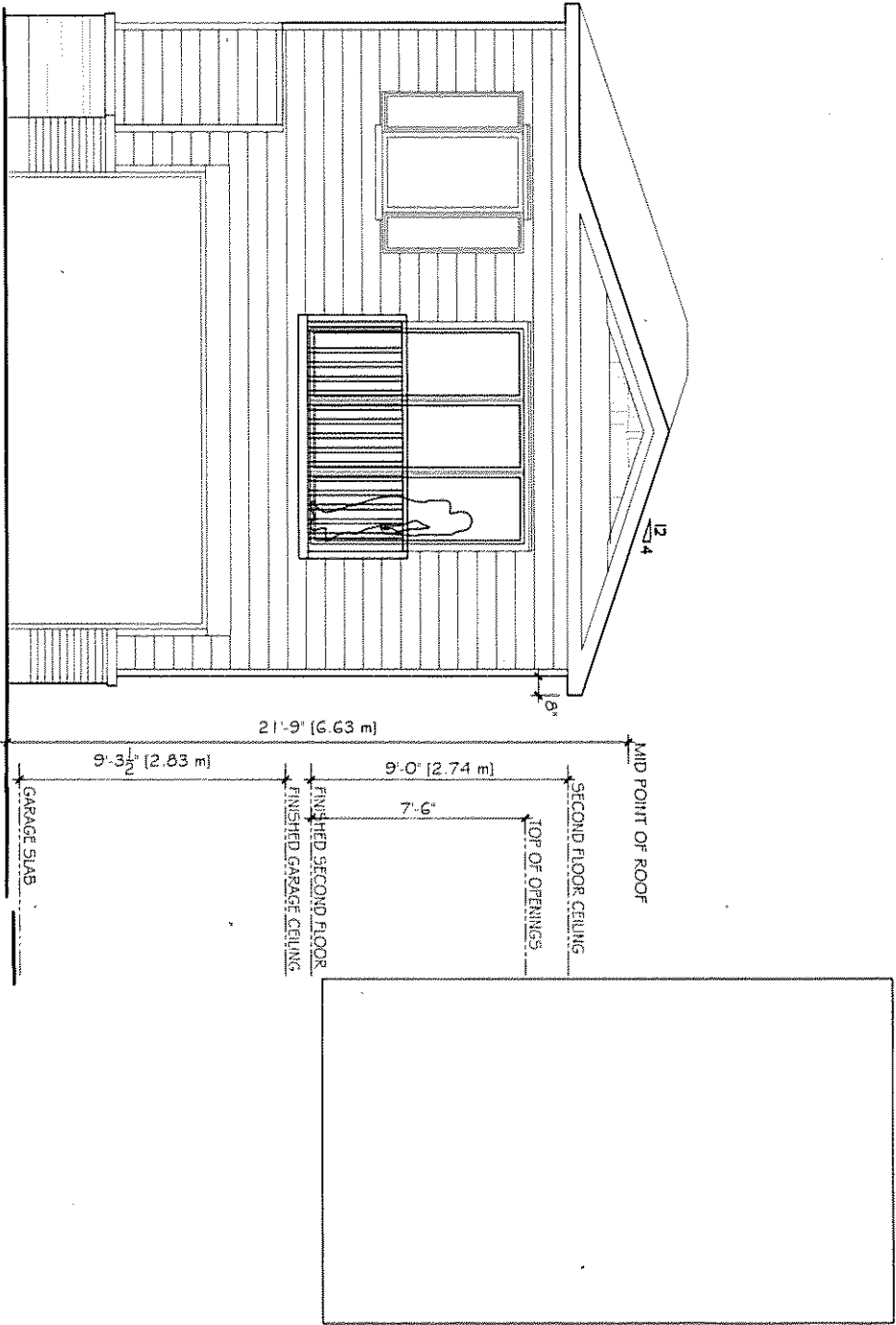

20 STONE JUG AVE.
 MARKHAM, ON

1 EAST ELEVATION
 Scale: 1/4" = 1'-0"

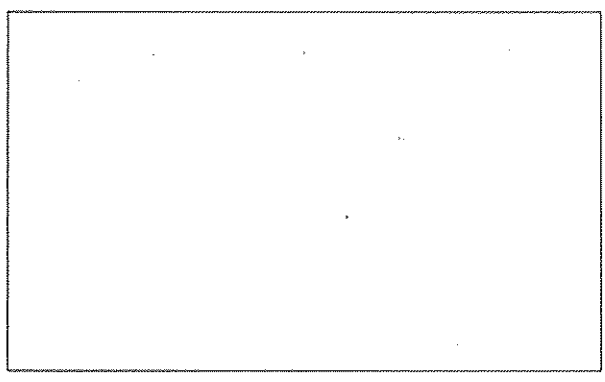
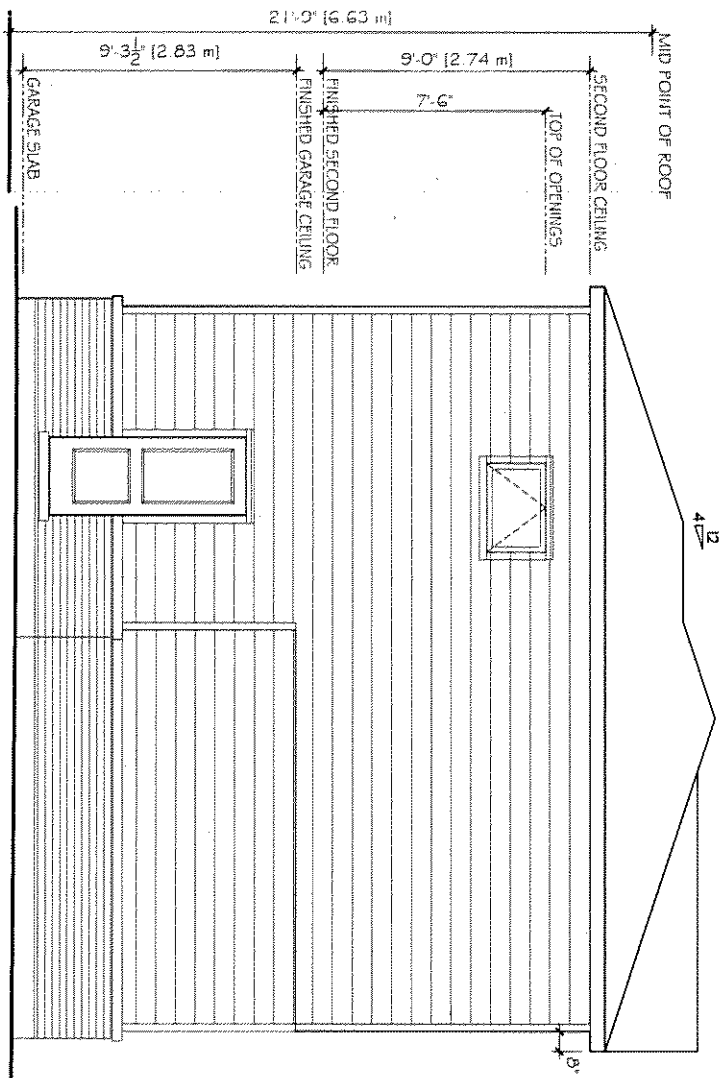

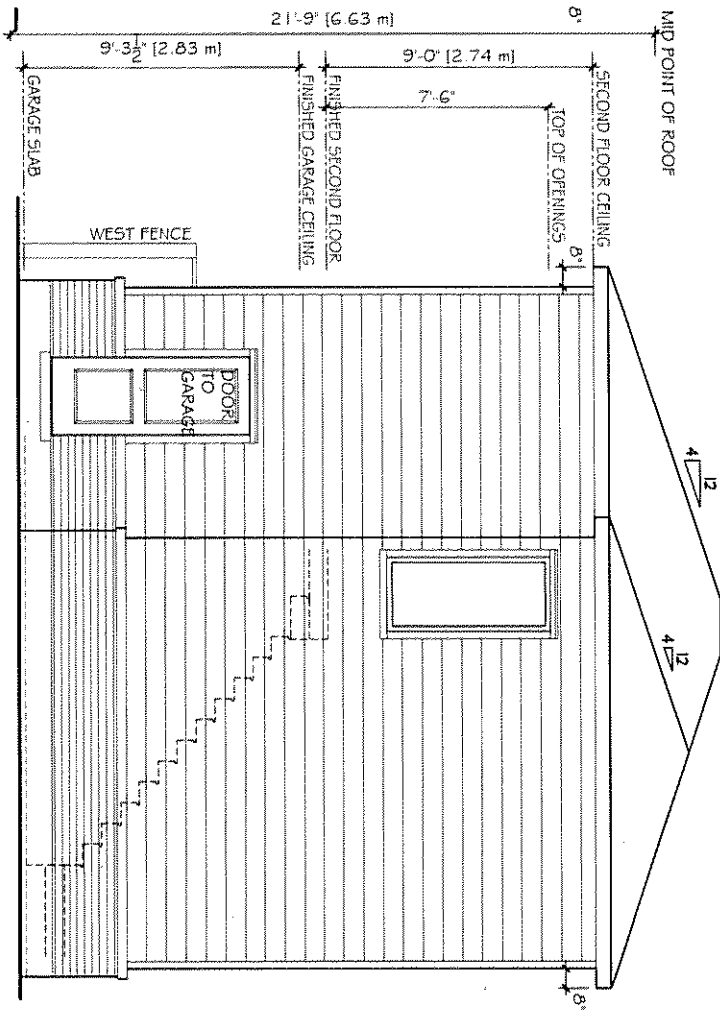

1 SOUTH ELEVATION
 SCALE: 1/4" = 1'-0"

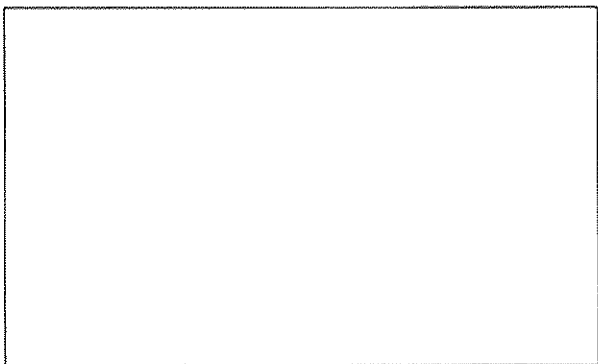

20 STONE JUG AVE.
 MARKHAM, ON

1 WEST ELEVATION

 Scale: 1/4" = 1'-0"

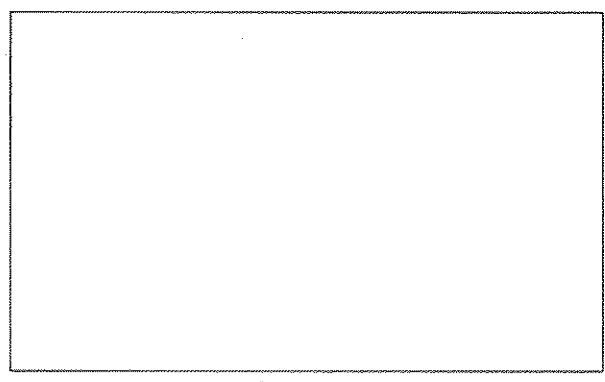
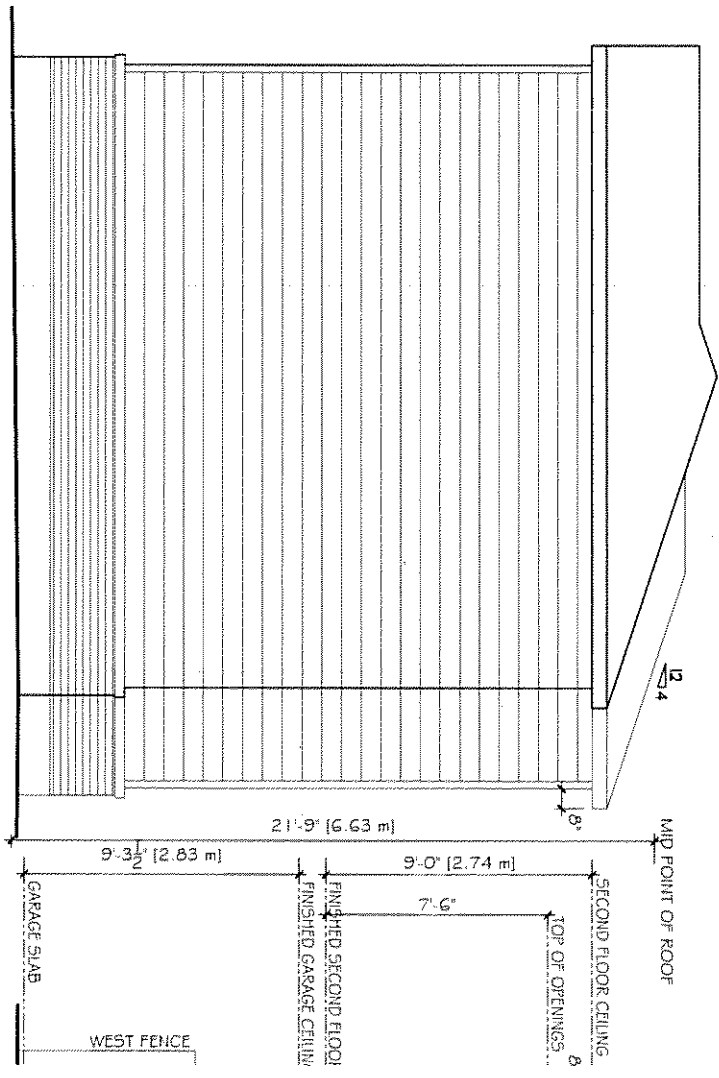

20 STONE JUG AVE.
 MARKHAM, ON

1
CROSS SECTION
 Scale: 1/4" = 1'-0"

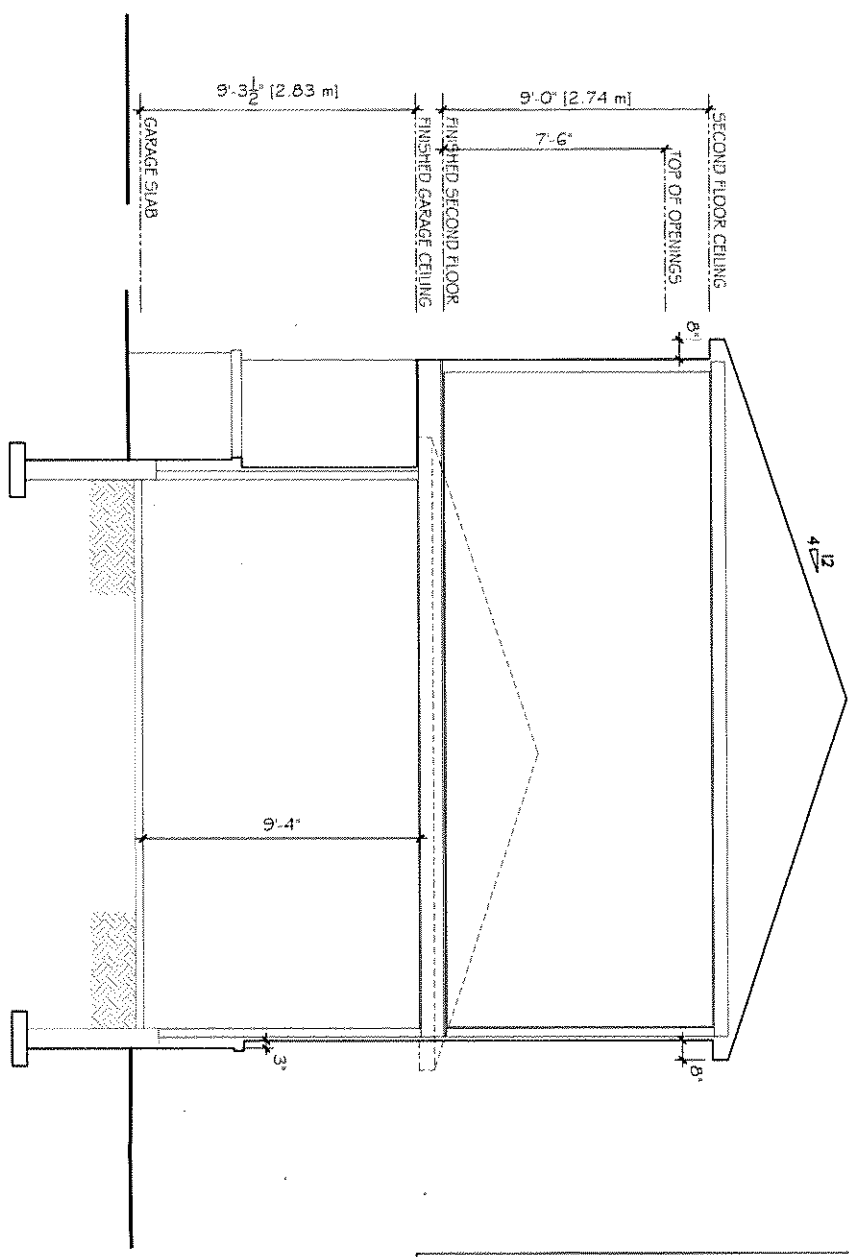

20 STONE JUG AVE.
 MARKHAM, ON

1 CROSS SECTION

 Scale: 1/4" = 1'-0"

20 STONE JUG AVE.

 MARKHAM, ON

CROSS SECTION

 JAN. 14, 2019

A-4.2

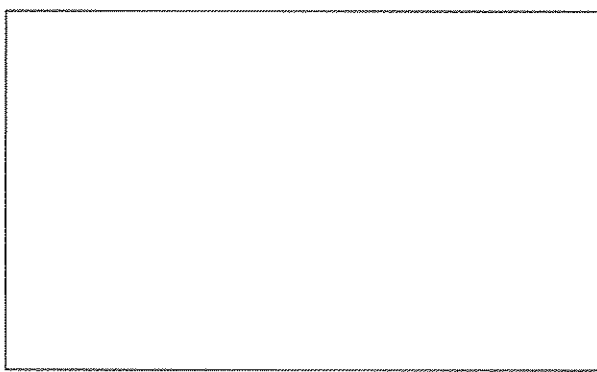
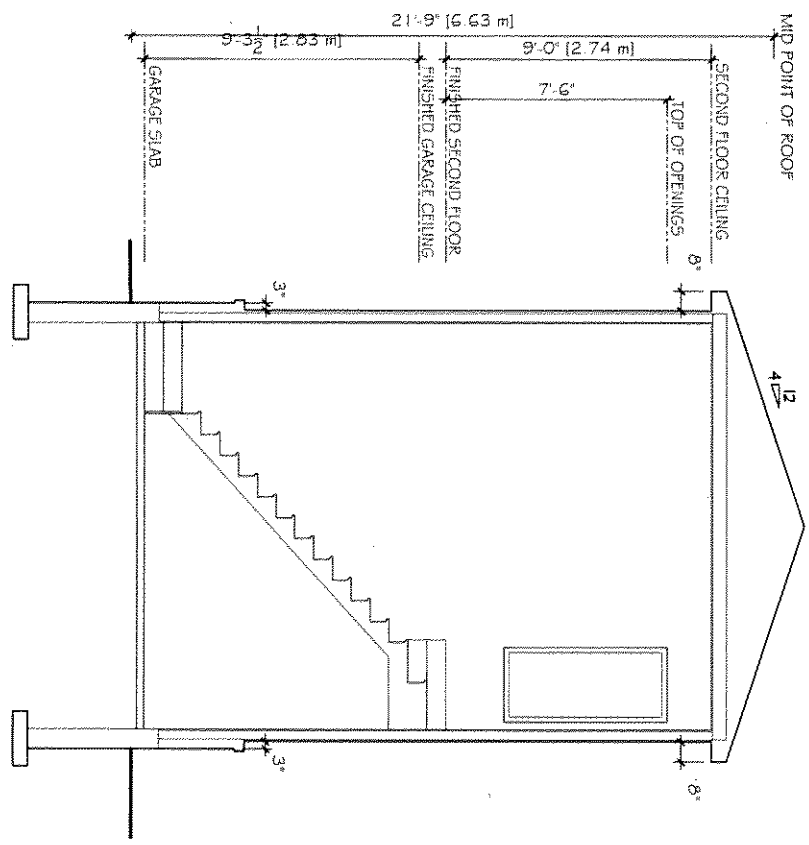



First Step Design Limited
16600 Bayview Ave. Suite 207
Newmarket ON, L3X 1Z9

April 23, 2019

City of Markham,
Development Services,
101 Town Centre Blvd.,
Markham, ON L3R 9W3

Attention: Secretary-Treasurer

Re: Committee of Adjustment, Minor Variance application for 20 Stone Jug Ave., Markham

Dear Members of the Panel,

Please accept the following application for minor variances as identified by the zoning ZPR dated February 21, 2019 and completed by Tori Tsang, Zoning Examiner on ZPR 19 111615 ZPR. The review was completed on single family semi-detached existing dwelling with detached rear lane garage, to build a secondary dwelling (coach house) located above garage.

The following describes the nature and extent of relief applied for and provides reasons as to why it is not possible to comply with the provisions of the by-law.

1) Section 7.432.2 b)

To permit minimum setback of 4.0m for a detached private garage from the main building on the lot, whereas minimum of 5.0m is required.

The proposed variance of 1.0m into the 5.0m setback is due to the proposed new stairs to provide the access to the second storey for the dwelling. By placing the stairs at the rear of garage, this allows the garage to keep the existing 2 parking spaces. We submit that this variance is minor in nature.

2) Section 6.3.1.7b)

To permit maximum lot coverage of +/-20.9% for a detached garage that accessed by lane, whereas maximum of 18% is permitted.

The proposed variance for the lot coverage over the maximum is equal to 6.89m² or 74.2 ft². This variance is also due to the addition of the rear stairway at garage structure to allow the existing 2 parking spaces within the garage for their minimum area. We submit that this variance is minor in nature.



3) By-law 28-97 Section 3

To exempt the require parking space for the accessory dwelling unit, whereas 1 parking space is required.

We are proposing to exempt the required parking space for the new unit and the 2 current garage parking spaces be divided for 1 per dwelling unit.

Summary

The surrounding land development of 20 Stone Jug Ave., in the neighbourhood of Cornell, is experiencing building developments similar in nature to our proposed plan and therefore we submit our proposed design is considered desirable for the appropriate development of the land.

Thank you for your consideration of our application.

Sincerely,

A handwritten signature in black ink, appearing to read "C. McPhee".

Cindy McPhee, M.A.A.T.O.
Principal Designer / President
First Step Design Limited

APPENDIX "C"
CONDITIONS TO BE ATTACHED TO ANY APPROVAL OF FILE A/39/19

1. The variances apply only to the proposed development as long as it remains;
2. That the Owner register the home as a two-unit house with the City of Markham Fire & Emergency Services Department, and satisfy any and all conditions for registration, to the satisfaction of the Fire Chief; and
3. That the variances apply only to the subject development, in substantial conformity with the plan(s) attached as 'Appendix A' to this Staff Report and received by the City of Markham on May 22nd, 2019, and that the Secretary-Treasurer receive written confirmation from the Director of Planning and Urban Design or designate that this condition has been fulfilled to his or her satisfaction.

CONDITIONS PREPARED BY:



Aqsa Malik, Planner, Zoning and Special Projects