

# Memorandum to the City of Markham Committee of Adjustment

June 13, 2019

**File:** A/53/19  
**Address:** 11 Princess St Markham Village  
**Applicant:** Cui Zhu Liang,  
**Agent:** Russ Gregory, Gregory Design Group  
**Hearing Date:** June 26, 2019

The following comments are provided on behalf of the Heritage Districts Team. The applicant is requesting relief from the following requirements of By-law 1229, as amended:

- a) **Section 11.1:**  
To permit a minimum front yard setback to porch of 5.51m, whereas the By-law requires a minimum front yard setback of 7.62m;
- b) **Section 11.1:**  
To permit a minimum rear yard setback to porch of 3.88m, whereas the By-law requires a minimum setback of 7.62m;
- c) **Infill By-law 99-90, Section 1.2 (vi):**  
To permit a Net Floor Area (NFA) of 50.70 percent, whereas the By-law permits a maximum NFA of 45 percent;
- d) **Infill By-law 99-90, Section 1.2 (i):**  
To permit a maximum building height of 10.9m, whereas the By-law permits a maximum building height of 9.8m;
- e) **Infill By-law 99-90, Section 1.2 (iii):**  
To permit a maximum building depth of 16.91m, whereas the By-law permits a maximum building depth of 16.76m;

as they relate to a proposed two storey single detached dwelling.

## BACKGROUND

### Property Description

The subject property is located within the Markham Village Heritage Conservation District, and contains a brick bungalow dating from the mid-1950s and a number of mature trees. The immediate neighbourhood context on Princess Street includes other single-detached dwellings varying in age from the late 1940s to recent. There is a one-storey heritage building on the property immediately to the south, addressed as 88 Main Street South, positioned closer to Main Street than to Princess Street. Directly across the street is a natural area that is part of Milne Park.

The lot frontage is 27.86m, the depth is 30.08m, and the lot area is 702.0m<sup>2</sup>.

### Proposal

The applicant proposes to construct a new two storey dwelling with an attached two-car garage to replace the existing bungalow. The proposed GFA is 353.5m<sup>2</sup> (3,590ft<sup>2</sup>). The Minor Variance application is related to Site Plan Control application SPC 19 122591, currently under review by the City.

## **Official Plan and Zoning**

### Official Plan 2014

The Markham Official Plan 2014 designates the subject property "Residential – Low Rise" which provides for low-rise housing forms. Site-specific policies that apply to this part of Markham Village contained in Section 9.13.4.8 of the Official Plan 2014 limit the building types to single detached and semi-detached dwellings with a maximum height of two storeys.

### Zoning

The subject property is zoned R2 – Residential under By-law 1229, as amended. The proposed use is permitted under the By-law. This area is subject to Infill B-law 99-90.

### Zoning Preliminary Review

The applicant has not applied for a Zoning Preliminary Review.

### **Heritage Status**

The subject property is designated under Part V of the Ontario Heritage Act as part of the Markham Village Heritage Conservation District. The existing dwelling is a Type C building in the District Plan. It is not a heritage building, therefore its replacement with a new dwelling constructed according to the policies and guidelines of the District Plan is appropriate.

### **Applicant's Reasons Why it is Not Possible to Comply with the Provisions of the Zoning By-law**

On the application form the applicant stated "To construct a new two storey brick house."

### **COMMENTS**

The Planning Act states that four tests must be met in order for a variance to be granted by the Committee of Adjustment:

- a) The variance must be minor in nature;
- b) The variance must be desirable, in the opinion of the Committee of Adjustment, for the appropriate development or use of land, building or structure;
- c) The general intent and purpose of the Zoning By-law must be maintained;
- d) The general intent and purpose of the Official Plan must be maintained.

### Heritage Markham Committee

Heritage Markham Committee reviewed the Minor Variance application at its meeting of June 12, 2019. Some of the committee members expressed concern about the size of the proposed dwelling. Staff noted that the proposed house is smaller than some of the newer dwellings on the same street. After further discussion, the committee decided it had no comments on the requested variances from a heritage perspective.

### Engineering and Urban Design

Lot grading, servicing and tree preservation matters are being reviewed in detail as part of the Site Plan Control application. No significant issues have been identified at the preliminary stages of the staff review.

### Heritage Planning

Princess Street does not contain any buildings of cultural heritage value or interest. The street is mix of modestly-scaled older dwellings and larger, more recent two storey dwellings. The emerging character of the street is large custom homes in various interpretations of the neo-traditional style. The proposed dwelling, at 3,950ft<sup>2</sup>, is smaller than recent projects at 23 Princess Street (4,701ft<sup>2</sup>) and 27 Princess Street (5,100ft<sup>2</sup>). The project at 23 Princess Street was approved with a Net Floor Area of 53%. The proposed new dwelling at 11 Princess Street is requesting a Net Floor Area of 50.7%, a smaller variance from the By-law requirement of 45%.

Staff has no objection to the requested variances on the basis that the proposed development is in keeping with the emerging character of Princess Street and does not exceed previous approvals for other new dwellings in the immediate vicinity.

### **PUBLIC INPUT SUMMARY**

At the time of writing of this memorandum, no written submissions were received relating to this application.

### **CONCLUSION**

It is the opinion of the Planning staff that the requested variances are supportable and meet the four tests of the Planning Act. Staff is generally satisfied with the location, scale and form of the proposed new dwelling and do not have any concerns with the proposed development or the approval of the Minor Variance application.

The onus is ultimately on the applicant to demonstrate why they should be granted relief from the requirements of the zoning by-law, and how they satisfy the tests of the Planning Act required for the granting of minor variances.

Please see Appendix 'A' for conditions to be attached to any approval of this application.

PREPARED BY:

  
George Duncan, Senior Heritage Planner

REVIEWED BY:

  
Regan Hutcheson, Manager, Heritage Planning

**APPENDIX 'A'**

**CONDITIONS TO BE ATTACHED TO ANY APPROVAL OF FILE NO. A/53/19**

1. The variances apply only to the proposed development as long as it remains;
2. That the variances apply only to the subject development, in substantial conformity with the plans dated May 23, 2019 attached as APPENDIX 'B' to this staff report, and that the Secretary-Treasurer receive written confirmation from the Director of Planning and Urban Design or designate that this condition has been fulfilled to their satisfaction;
3. That the Owner submit to the Secretary-Treasurer a copy of the Site Plan Endorsement memo for the proposed development.

CONDITIONS PREPARED BY:

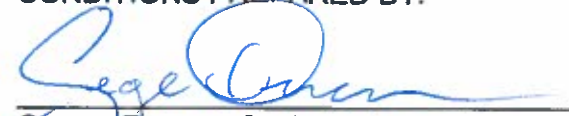
  
George Duncan, Senior Heritage Planner

APPENDIX 'B'

<b>SPECIAL NOTES:</b> ALL CONSTRUCTION IS TO CONFORM TO SECTION "N" OF THE CHICAGO BUILDING CODE (LATEST EDITION). CONTRACTOR SHALL CHECK AND VERIFY ALL NOTES AND DIMENSIONS. DO NOT SCALE DRAWINGS. OWNER / CONTRACTOR / DESIGNER IS RESPONSIBLE TO RE-CLASH AND DESTROY ALL PREVIOUS AND UNREVISED COPIES OF THIS DRAWING. THESE DRAWINGS ARE THE PROPERTY OF THE GREGORY DESIGN GROUP AND / OR ITS CLIENTS ONLY. BUILDING PERMITS SHOULD BE OBTAINED PRIOR TO COMMENCING CONSTRUCTION.	<b>REVISIONS AND DATA</b> DATE This drawing has been revised and the responsibility for the accuracy and any other specifications and notes the responsibility set out in the Chicago Building Code to be accepted by the Client (Building Code) for its design.
	<b>QUALIFICATION INFORMATION</b> Registered Professional Engineer State of Illinois No. 05857 Exp. 05/23/19
<b>PROJECT TITLE</b> SITE PLAN 11 PRINCESS STREET CITY OF MARKHAM	
 <b>THE GREGORY DESIGN GROUP</b> 16 CROWN STREET MARKHAM, ONTARIO L3R 2G6 416-520-0978 shane@gregorydesigngroup.net	
<b>SCALE</b> 1:200	<b>DATE</b> 05/23/19
<b>PROJECT NUMBER</b> 2146-19	<b>SHEET NUMBER</b> SP-1
<b>DRAWN BY</b> S. Gregory	<b>CHECKED BY</b> R.G.

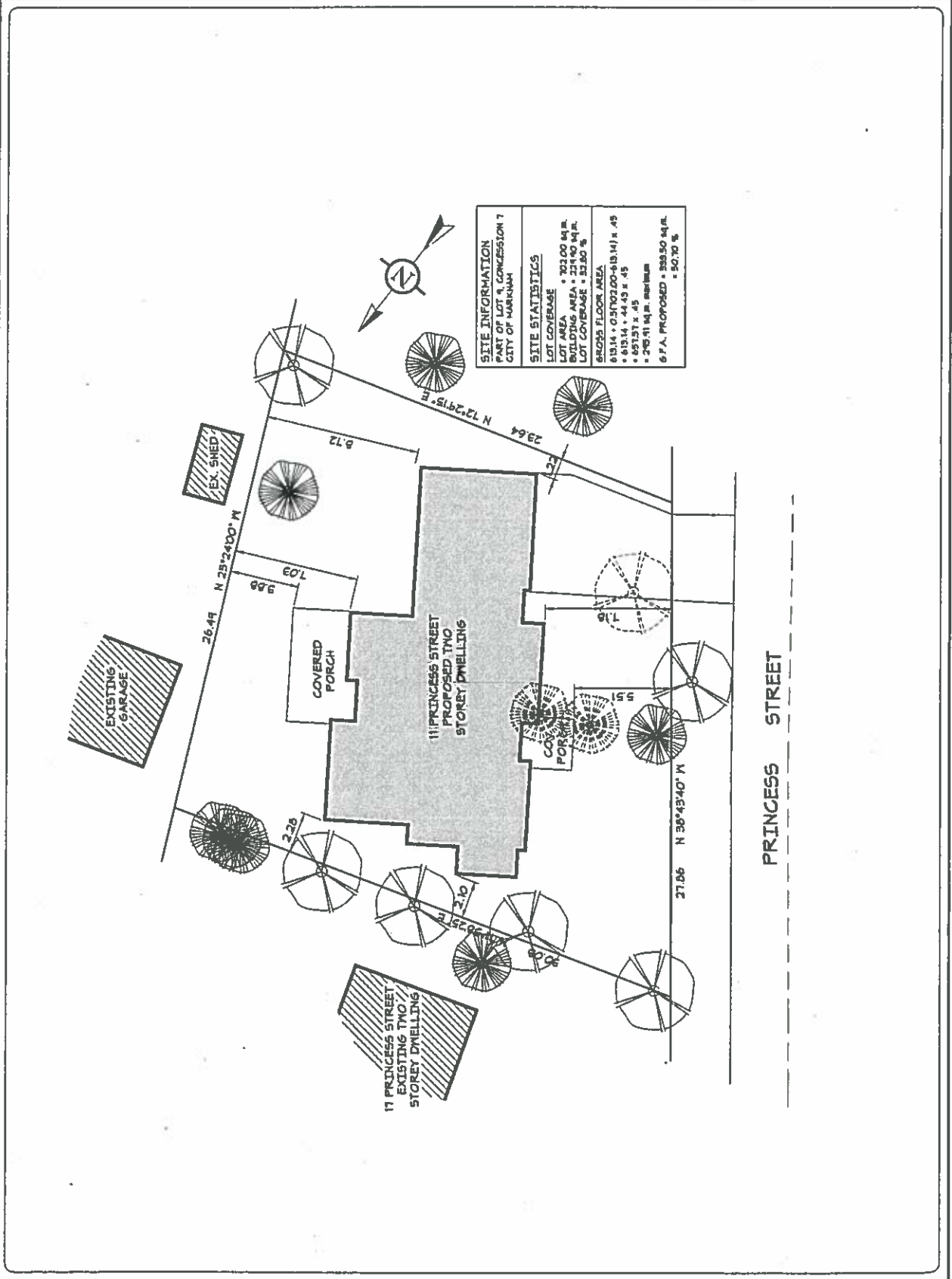

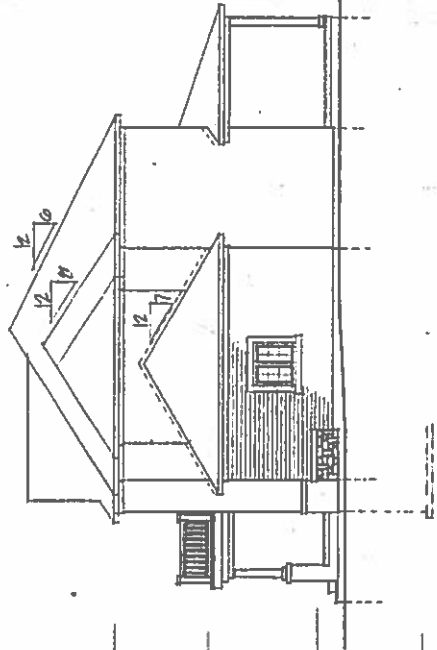

SOUTH SIDE

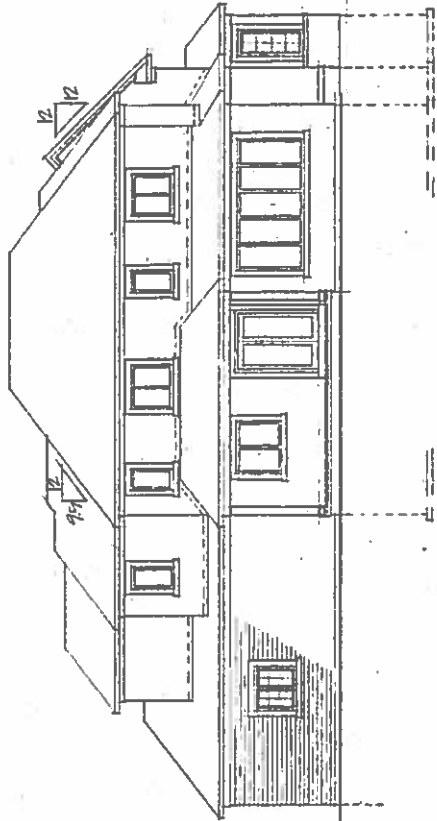

REAR ELEVATION - EAST

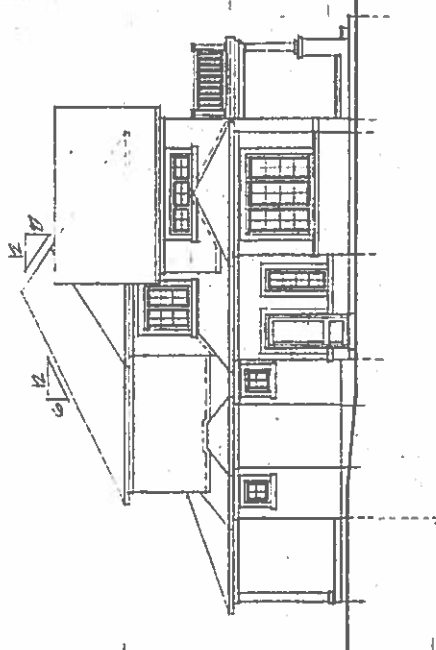

NORTH SIDE

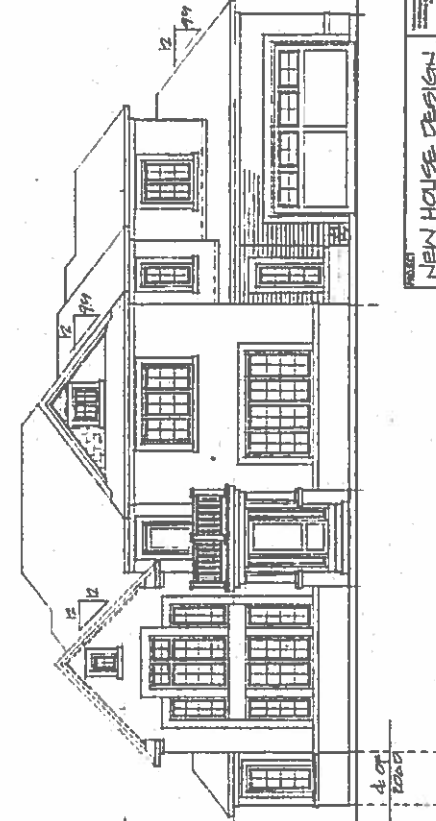

FRONT ELEVATION - WEST

PROJECT	NEW HOUSE DESIGN 11 PRINCESS ST. CITY OF MARIHAM
DESIGNER	THE GREGORY DESIGN GROUP 18 CHURCH STREET MARIHAM, ONTARIO, L3P 2L6 (416) 720-4687 greg@gregorydesigngroup.net
DATE	2006-19
SCALE	1/4" = 1'-0"
NO.	7