

## **9.4 New Buildings**

---

### **9.4.1 Overview**

The overall heritage character of the District is composed of buildings, streetscapes, landscapes, and vistas. This overall character has more significance than any individual building, even if it is one of the finest. Within the design of any individual building, architectural elements contribute to the character of the public realm of the street. Massing, materials, scale, proportions, rhythm, composition, texture, and siting all contribute to the perception of whether or not a building fits its context. Different settings within the district have different characters of siting, landscaping and streetscaping.

New development within the District should conform to qualities established by neighbouring heritage buildings, and the overall character of the setting. Designs should reflect a suitable local heritage precedent style. Research should be conducted so that the style chosen is executed properly, with suitable proportions, decoration, and detail.

### **Guidelines**

It is highly recommended that owners engage design professionals skilled in heritage work for new buildings in the District.

## 9.4 New Buildings

### 9.4.2 Residential Village

#### Overview

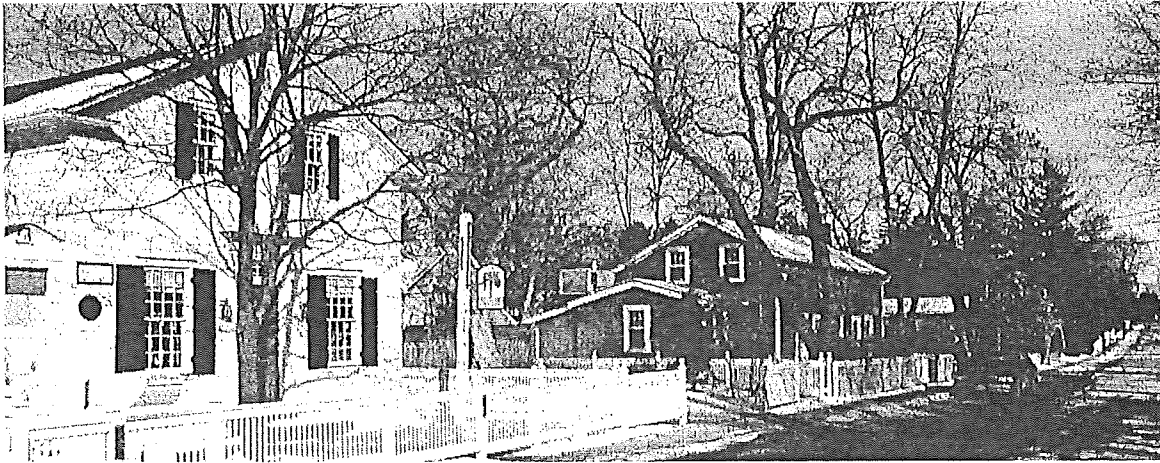

The residential village has a variety of lot sizes, frontages, and setbacks. Houses were mostly of a modest scale, leaving generous yards on all sides. In the historic area front yards tend to be shallow compared to the rear yards, where space was needed for stabling, herb and vegetable gardens, and orchards. An early village household needed these means for self-sufficiency, and lawns and decorative planting were minimal. The use of the yards has changed, and they provide more pleasure and less production now, but to a great extent the original village scale has persisted. Building height, lot coverage, and density are all low. The streetscapes are unified by a canopy of trees, planted in front of, behind, and beside most houses. Elements that define the heritage character of the residential village include:

- Generous lot sizes and modest house sizes, compared to historic urban development or recent suburban development;
- A variety of front-yard setbacks;
- The generous presence of mature trees, in addition to decorative shrubbery, in the front, side, and rear yards.

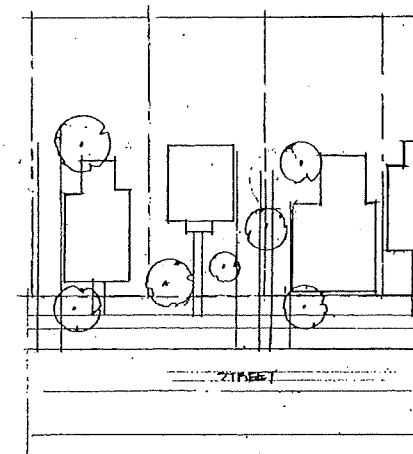

Buildings and trees share in forming the streetscape.

## 9.4 New Buildings

---

### 9.4.2.1 Streetscapes

Each street in the District lends itself to a certain form of infill architecture:

#### Colborne Street

Colborne Street was named after Sir John Colborne, the Lieutenant Governor of Upper Canada from 1828 to 1836. This is a very short local street, and the street that perhaps best captures the village-like character of Thornhill.

The roadway is narrow, with a low rolled curb and a sidewalk of precast pavers on the north side, and a full rural profile, with a shallow drainage ditch on the south. White wood picket fences are a predominant feature along the street, and there is a wealth of mature trees and planting. Wooden benches are built into the fencing near the Library at 10 Colborne Street. The rectory of St. Volodymyr's Church provides an axial feature at the east end of the street.

The street is very rich in heritage resources. Of the 22 properties that front on the street, or flank it at Yonge Street:

4 are designated under Part IV of the *Ontario Heritage Act*,

11 are graded "Class A",

3 are graded "Class B".

The designated houses, and the majority of the Class A houses are in the Georgian Style, and wood clapboard is the predominant historical cladding material. Several newer houses, including mid-20<sup>th</sup> century DVA houses share the basic form of the Georgian Cottage. Nevertheless, the street contains a range of other styles. Cladding materials include brick, stucco, and board-and-batten.

The scale of the buildings on Colborne Street is quite modest, with most of the houses being 1- or 1 ½ -storeys in height. Only Nos. 25 and 34 are a full 2 storeys high.

### Guidelines

1. New construction should respect the existing cladding material used on the street.
2. Colborne Street contains the District's greatest concentration of early Georgian houses. New construction should reflect the scale and predominant architectural style of the street.
3. The use of white wooden picket fences, which are a characteristic feature of the street, is encouraged. See Section 9.6.4 for further details on fencing.

## 9.4 New Buildings

---

### 9.4.2.1 Streetscapes cont'd

#### Eliza Street

Eliza Street was named after Eliza Frizzell, whose family owned the land through which the street runs. It is a short cul-de-sac, terminating in a turning circle adjacent to Thornhill Summit Drive. The turning circle is curbed, but the rest of the street has a full rural profile with shallow drainage ditches on either side. Planting includes a mixture of mature deciduous and coniferous trees. Not many front yards are fenced.

All of the buildings are graded "Class C", although many are modern renditions of historical styles, predominantly Victorian. The scale of the houses is generally modest: there are three 2-storey houses; the other five are 1 ½ storeys. Cladding materials include brick, stucco, and board-and-batten.

The character of the street is compromised at the north end, where the west side of the turning circle overlooks the parking lots of large Yonge Street commercial properties. Just south of that, the parking behind the former Post Office site at 7751 Yonge Street is screened by a high stockade fence, but this site has a high redevelopment potential. The fact that this site faces or flanks the majority of the houses on Eliza Street will present substantial design challenges.

#### Guidelines

1. New construction should respect the existing cladding material used on the street.
2. The existing pattern of modern renditions of historical styles is encouraged.
3. The use of white wooden picket fences is encouraged. See Section 9.6.4 for further details on fencing.
4. The interface of any new development on Yonge Street properties should screen views from Eliza Street into the new development.

## 9.4 New Buildings

### 9.4.2.1 Streetscapes cont'd

#### Church Lane

Church Lane takes its name from St. Luke's (now St. Volodymyr's) Church, which is the oldest surviving Catholic Church in York Region. It is a short, narrow north-south street, running from John Street to the edge of the Don River Valley.

The street had a full rural profile with shallow drainage ditches on either side. There is a flush sidewalk on the east side from John Street to Colborne Street.

There are only three properties with Church Lane addresses: Thornhill Cemetery, the St. Volodymyr's Church lands (formerly St. Luke's) at No. 15, and the Watson-Watt House at No. 26. All of these properties are graded "Class A", and St. Volodymyr's is designated under Part IV of the *Ontario Heritage Act*. The St. Volodymyr's Church lands include St. Luke's Cemetery, the 1847 church building, and the 1879 rectory.

The west side of the street has three flanking properties, of which 38 Colborne Street is graded "Class B", and 39 Colborne Street is designated under Part IV.

The street has an abundance of mature trees, and the Watson-Watt house is set in an English style garden. Considered as a whole, Church Lane is very high in heritage value.

#### Guidelines

1. The buildings on all three properties on Church Lane have high heritage value, and should be retained. Any new construction on these properties should be of an equally high quality.
2. Any new construction flanking on Church Lane should be of a quality and scale in keeping with the heritage resources on the street.

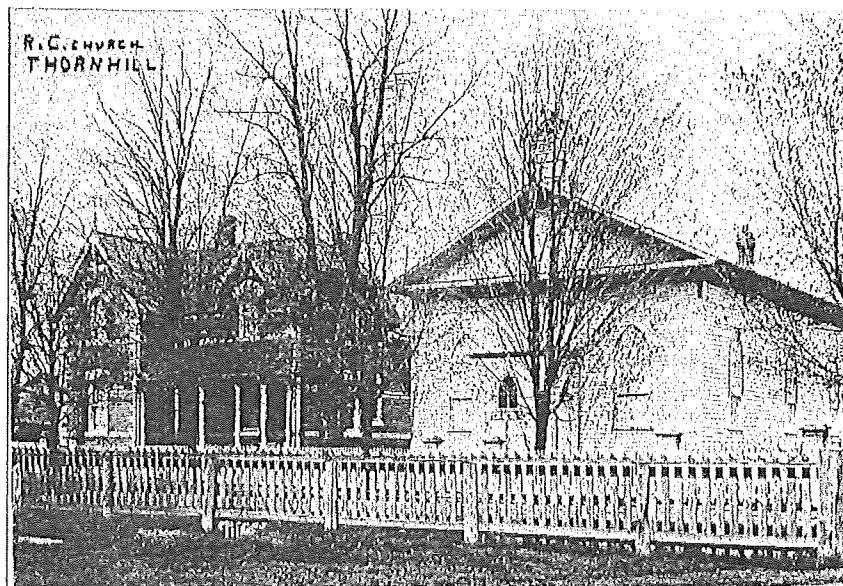

St. Luke's Roman Catholic Church [c.1900]. Built on Church Ln. at the top of Colborne St. in 1847 by John Edey. The brick manse on the left was built in 1879. Photographer unknown.

## 9.4 New Buildings

### 9.4.2.1 Streetscapes cont'd

#### John Street-Yonge St. to Church Lane

John Street, like Colborne Street, was named for Sir John Colborne. It had been previously known as Millbourne Road. It has always been Thornhill's eastward connection, as Centre Street in Vaughan has been the westward connection. It remains an important and heavily used road. The roadway has an urban profile, with full curbs. There's a sidewalk on the north side, but not the south.

Mature trees and planting are generous, with a mix of deciduous and coniferous species. Most properties do not have front yard fencing

John Street developed asymmetrically, as shown in the old aerial photograph opposite. The south side of the road remained farmland until well into the 20<sup>th</sup> century. Only the north side of the street, between Yonge Street and Church Lane, was part of the original historic village, and it still holds a wealth of 19<sup>th</sup> century houses. Of the 11 properties, 7 are graded "Class A" and 4 are graded "Class B". Three of the Class A properties are Victorian "Ontario Classic" and four are Georgian.

The south side of the street began development with the construction of No 25, an Arts and Crafts bungalow, in 1927. It took about three decades for the streetscape to fill out, and of the 8 properties, four were built as mid-century Cape Cod style buildings, with the same Georgian design origins as the buildings across the street. As a result, there is a complementarity rarely found in buildings a century apart in age.

### Guidelines

1. The Georgian precedent, seen in both 19<sup>th</sup> century buildings on the north side of John Street, and the later Cape Cod style houses on the south side, is appropriate for new construction.
2. The use of white wooden picket fences is encouraged. See Section 9.6.4 for further details on fencing.



A 1927 aerial view of Thornhill, looking east. Yonge Street runs across the picture, and John Street runs up on the right. 25 John Street is the only house on the south side. On the north side, it's possible to identify houses up to 94 John Street, and the sidewalk has already been installed.

Weaver #337

## 9.4 New Buildings

---

### 9.4.2.1 Streetscape cont'd

#### John Street—East of Church Lane

Some of the houses east of Church Lane are as old as any in the District, but these were on farms, spaced out beyond the village. Older houses exist at 104, 111, 117, and 170 John Street. The historic house at 148 was moved to the site from Yonge Street in 1980.

As seen in the aerial photograph, the infill began first on the north side of the street, and of the surviving original houses in the photo, a majority are of the Arts and Crafts/Bungalow style.

The development of the south side, beginning in 1927, contains a few houses in this style, but the later Cape Cod/DVA style is more prevalent among the pre-1950 houses. Both sides of the street also have later infill housing from the mid-20<sup>th</sup> century to the present. These range from ranch bungalows, through split-level houses, to high modernism.

A number of recent developments, including both renovations and new houses, have been executed under the District Plan. The results have enhanced the character of the street. Often a minor change, such as the addition of a veranda or a change in doors and windows has made a house a better neighbour to the heritage resources in the District.

#### **Guidelines**

The use of modern renditions of Thornhill historical styles is recommended for new infill.

#### Leahill Drive

Leahill Drive is a very short road running north from John Street to Deanbank Drive. It has a full rural profile with shallow drainage ditches on either side. The only property bearing a Leahill Drive address is the Edey House, at No. 4, which was moved to this site from 7690 Yonge Street. This property is designated under Part IV of the *Ontario Heritage Act*.

The entire east frontage of the street is the flank of the very deep lot at 94 John Street. The house is a modest Bungalow that has not been altered since its construction. Most of the west frontage is the flank of 90 John Street, which nevertheless uses Leahill Drive for its principal façade. This house is graded "Class A".

The street is graced with mature trees and planting, and 90 John Street is bordered by a substantial hedge.

#### **Guidelines**

If new infill houses were ever needed on this street, the use of modern renditions of Thornhill historical styles is recommended.

## 9.4 New Buildings

---

### 9.4.2.1 Streetscapes cont'd

#### Deanbank Drive

Deanbank Drive began life as a farm lane, which can be seen at the very top right of the aerial photograph, running from the large white barn toward John Street—the intersection is just beyond the edge of the photo.

The first, northward leg of Deanbank Drive retains its character. It is very narrow—two cars couldn't comfortably pass, and has a full rural profile. It is closely lined with mature trees, both deciduous and coniferous. The lovely barn-red outbuilding of 104 John Street lends a thoroughly rural touch.

The old lane was extended, turning westward in line with the rear lot lines of 68-84 John Street. Numbers 11, 18, and 22 Deanbank Drive were built in the 1950s along this extension, and in 1962 Napier Simpson built his neo-Regency house at No 24. The Cape Cod cottage at No. 20 was built in the 1970s.

There was further development in the 1980s, with the road extending, fishhook fashion, and ending on a turning circle to the northwest of the Napier Simpson house. The houses were constructed or approved before the District Plan came into force, and they range from modest Cape Cod-based ranch houses, to rather grand historicist villas. Some of these are skilfully proportioned and detailed, though the heritage precedent is often not local.

To a certain extent, Deanbank Drive is in a realm of its own. Extensive planting to the south and west of the Deanbank development separate it visually from the rest of Thornhill.

### Guidelines

The use of modern renditions of Thornhill historical styles is recommended for new infill.



## 9.4 New Buildings

---

### 9.4.2.2 Architectural Style

Architectural style is the term used to identify the characteristics of particular modes of construction, as defined by a variety of elements including geography, materials, influence, culture, economics, and history.

The style of new construction should be sensitive to its surroundings. It need not imitate exactly the older styles of existing local buildings, but should respond to the spirit of its surroundings. The measure of successful new construction within heritage areas is not the extent to which it stands out but its ability to blend in with its surroundings.

Existing architectural styles in the District include Georgian, Regency, Ontario Classic, Gothic Revival, and Arts and Crafts/Bungalow.

A Thornhill vernacular style is also evident which includes those regionally distinct buildings which are of no one particular style, but which resulted from a series of locally specific cultural and economic factors.

### Guidelines

1. The design of new buildings should be products of their own time, but should reflect one historic architectural style prevalent in the District.
2. A consistent approach to design detail for the chosen style should be used for all building elements.
3. It is important to recognise that the overwhelming characteristic regarding style in Thornhill is simplicity. Overly elaborate styles and others that are not compatible with the local village context should be avoided.
4. The predominant historic architectural style and building form on the street should be considered when selecting a particular style for new construction.

A detailed description of the principal historic styles in the District can be found in Section 9.1.

## 9.4 New Buildings

### 9.4.2.3 Overall Scale

An important attribute of the Heritage District is the distinctive form and massing commonly found on a traditional streetscape, with the predominant building form being the small- to medium-sized, single detached dwelling. Established before the introduction of the automobile, the local streets often possess a rhythm that emphasises the individual house.

#### Guidelines

1. While new construction may vary in scale from the surrounding development, it should fit in with the existing streetscape in terms of rhythm, alignment, and spacing.
2. The ratio of green space to building mass and the sideyard setbacks should be generally consistent with the character of adjacent properties.
3. Where a building is proposed that is substantially larger than the typical buildings found on the street, the scale of the structure can be reduced by breaking up the façade and overall building mass into elements that proportionally reflect the adjacent building forms.



1. Large empty lot/redevelopment site

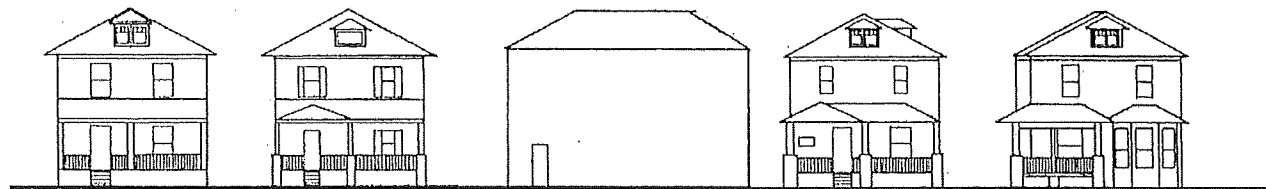

2. **Not Appropriate:** The new dwelling is too massive, and ignores the rhythm, spacing, and alignment of the existing streetscape.



3. **Appropriate:** The dwelling's scale is reduced through articulation of the façade with part of the dwelling set back. Rhythm, spacing and alignment are based on the existing context.

## 9.4 New Buildings

### 9.4.2.4 Building Form: Directional Emphasis

The building stock of the District varies between a vertical and horizontal directional emphasis.

Directional emphasis is influenced by the height of the building, massing and articulation, and placement of details such as roof pitch, gables, windows, etc.

The general rule of new construction in the District is that it should blend in, but not overwhelm the heritage character of the District.

#### Guidelines

New residential construction should reflect the typical directional emphasis and building form of the surrounding streetscape.



Appropriate



Too Vertical

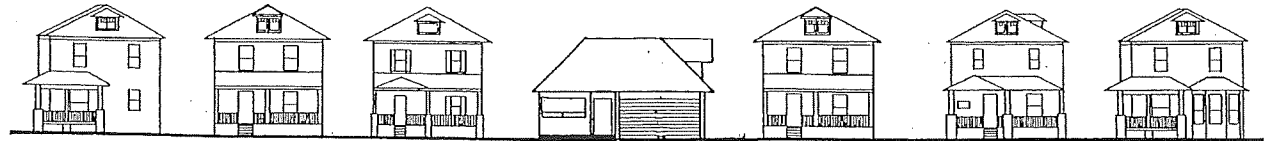

Too Horizontal

## 9.4 New Buildings

### 9.4.2.5 Building Form: Height

The height of most of the residential building stock in the District is relatively constant and falls between one-and-a-half and two storeys. The continuity of height and massing in the District is an important contributor to the distinctive character of the area.

Infill construction that is significantly taller than the adjoining structures will overwhelm the existing heritage character of the street and should be avoided.

#### Guidelines

1. New construction should be compatible with the traditional height pattern in the District of one-and-a-half and two storeys, and should have regard for the adjoining buildings on the street.
2. The height of new residential buildings should not be less than 80% or more than 120% of the average height of the residential buildings on immediately adjacent properties.
3. In order to ensure that height and massing of new development are compatible, all proposals for new buildings in the District should include a detailed streetscape elevation of the adjoining structures and features. Corner lots require two streetscapes. If necessary, photographs may also be used.



Appropriate



Too Tall

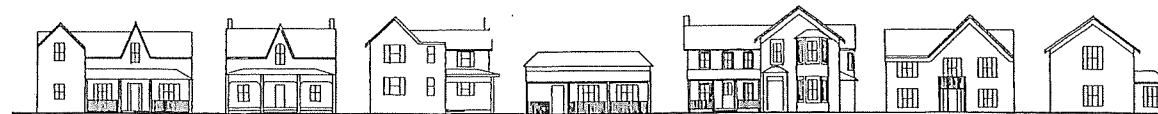

Too Low

## 9.4 New Buildings

### 9.4.2.6 Location and Setbacks

The traditional pattern of residential setbacks is an important contributor to the character of the Heritage District. Buildings are generally located closer to the street than those in most modern suburban developments, while garages and ancillary buildings are located towards the rear. The pattern is typically more ordered in the older core area.

#### Guidelines

1. New construction should respect the overall setback pattern of the streetscape on which it is situated. Where the minimum requirement for front yards does not permit this, appropriate variances to the zoning by-laws should be sought.
2. Where there are areas of significant variation in the location of adjacent buildings, the front yard setbacks of new residential infill should be defined either as the average of the setbacks of the adjoining properties, or where appropriate for historical reasons, aligned with the adjacent heritage buildings.
3. New buildings should generally be located with the front façade parallel to the roadway.
4. Ancillary buildings should be located towards the rear of the lot. Garages, in particular, should not form part of the front façade.

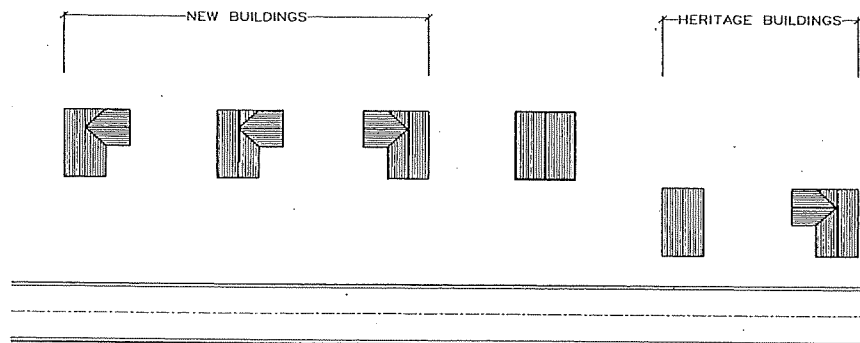

**Not Appropriate:** Setback consistent with new buildings

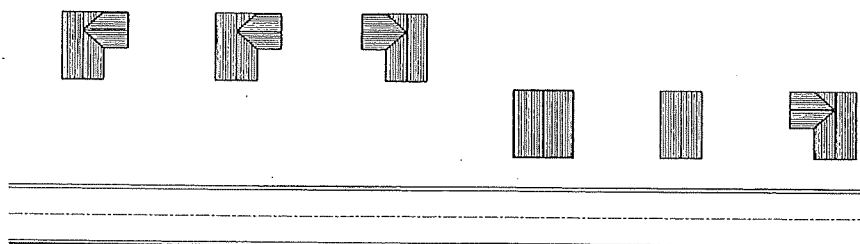

**Appropriate:** Setback consistent with Heritage buildings

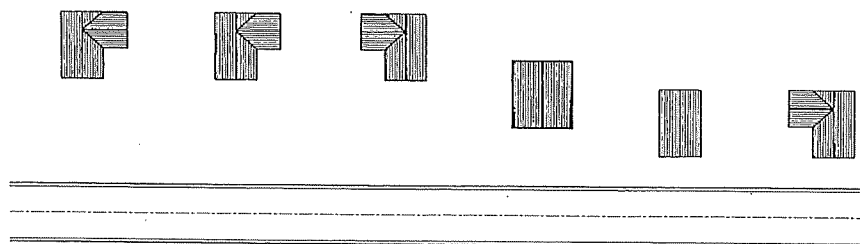

**Appropriate:** Setback enhances streetscape by mediating between new and old

## 9.4 New Buildings

### 9.4.2.7 Roofs: Appropriate Styles

The majority of roof forms in the District are of gable form, with a relatively steep pitch. This form should generally be used. Pitches can be shallower, but should not be less than a 6/12.

#### Guidelines

1. Roof design in the District should be compatible with the historic roof type forms in the village and the selected building style.
2. The extent of roof overhang should be appropriate to the architectural expression of the building.
3. Gambrel and gable roofs are appropriate for outbuildings.
4. Hipped roofs are preferred for taller buildings in order to minimize the perceived height.

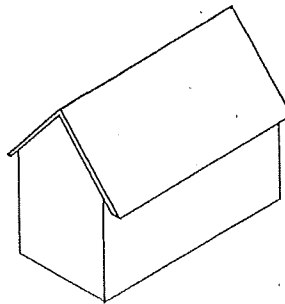

Gable

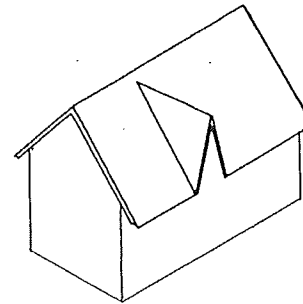

Centre Gable

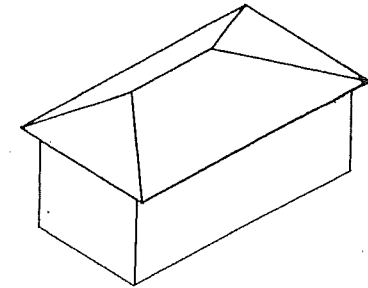

Hipped

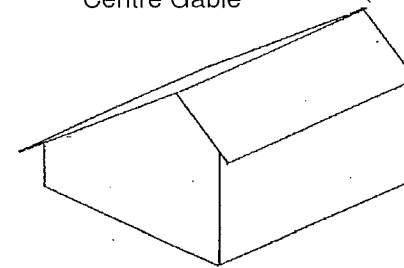

Saltbox

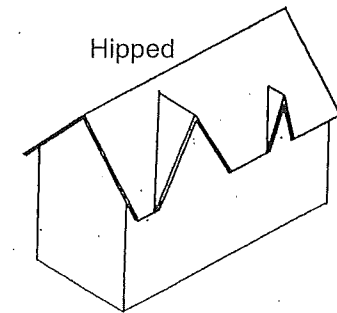

Double Gable

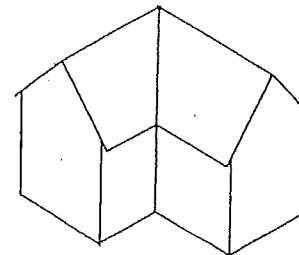

Ell gable

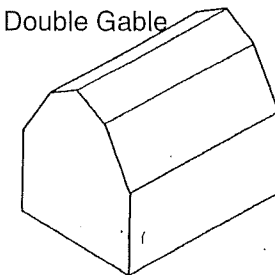

Gambrel

## 9.4 New Buildings

### 9.4.2.8 Roofs: Inappropriate Styles

The consistency and compatibility of the existing roof types in the District are significant contributors to the character of the area. Roof types and features which detract from the character of the area are not supported.

#### Guidelines

1. Flat or shallow roofs should be avoided.
2. Massive and monolithic roof volumes should be avoided.
3. Visible rooftop mechanical equipment should be avoided. If installation is unavoidable, appropriate screening techniques should be introduced.
4. Rooftop patios are not appropriate and are not supported in the District.

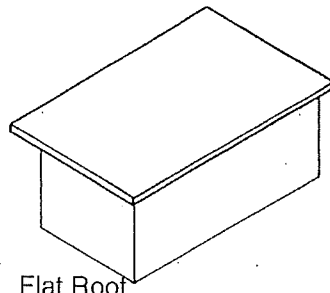

Flat Roof

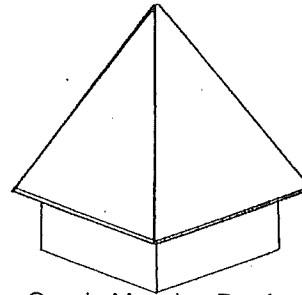

Overly Massive Roof

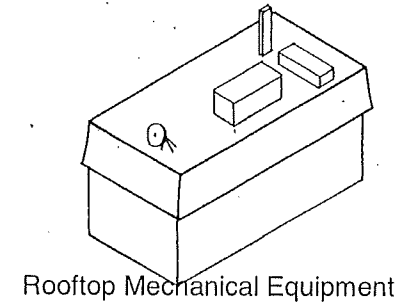

Rooftop Mechanical Equipment

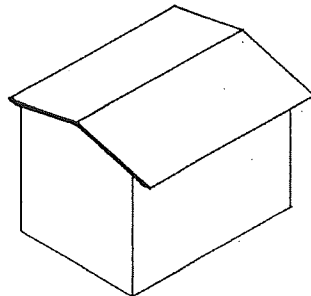

Low Pitched Roof

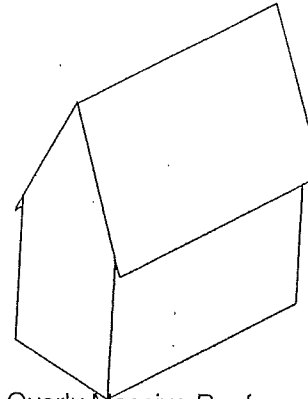

Overly Massive Roof

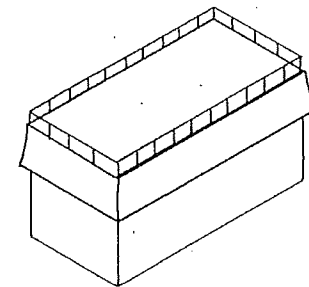

Rooftop Patio

## 9.4 New Buildings

### 9.4.2.9 Chimneys

In the late 19<sup>th</sup> century, the primary source of heating was wood or coal fireplaces. This had an impact on the architecture with the presence of internal chimneys on most roof-lines, typically at the gable ends. Today, the heritage character of Thornhill is enhanced by the presence of a number of these historic chimneys.

On new construction, the presence of chimneys on the roof-line is one of the elements which help to make the new construction compatible with the heritage environment. This is particularly true on large roofs where chimneys help to break up the massing to a more appropriate scale.

Historic photographs of the area reveal details of a variety of historic chimneys, which may be referred to in new chimney design.

In those instances where a non-functional chimney is desired, a false shelf chimney could be considered.

#### Guidelines

1. Chimneys are important features of the roofscape and are encouraged in new construction.
2. The use of chimneys on large roofs as a means of breaking up the massing to a more appropriate scale is encouraged.
3. The design of historic chimneys should be used as a reference in new chimney design.

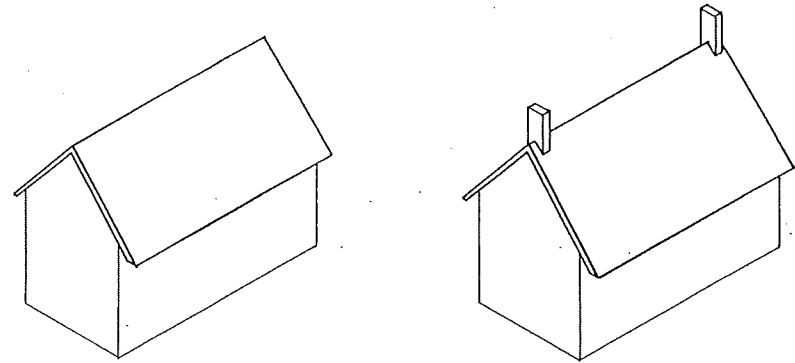

Chimneys can help break up the mass of large roofs.

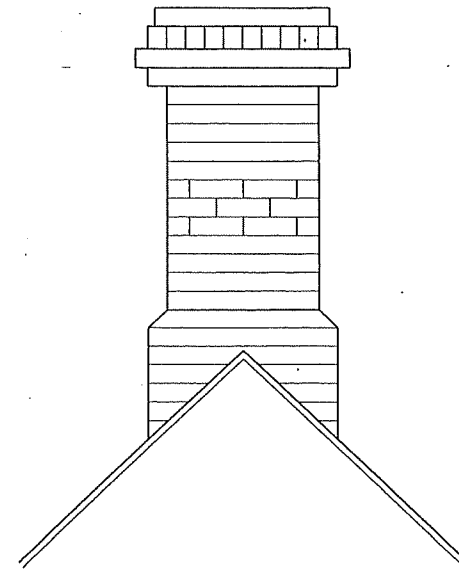

Historic Thornhill chimney detail, 19<sup>th</sup> century



## 9.4 New Buildings

### 9.4.2.10 Roofs: Materials

Many of the buildings in the District once had cedar shingle roofs. A majority of these have now been replaced by asphalt shingles; however, some structures have been restored to their original material. Porch roofs were typically clad in wood shingle or wood board-and-batten. The use of appropriate roof materials is encouraged.

#### Guidelines

1. Roof materials on all buildings in the District should reflect the traditional materials of the village. Traditional 3/8"-thick taper-sawn cedar shingles with a 4½" to 5½" weather are the most appropriate while asphalt shingles of an appropriate heritage colour, design, and weather are also acceptable.
2. Asphalt and wooden shingles as well as wood board-and-batten can be used on porch roofs.
3. Cedar shakes should only be used on barns and outbuildings.
4. Non-traditional roof materials, which are not supported, include clay tiles, metal, and vinyl.

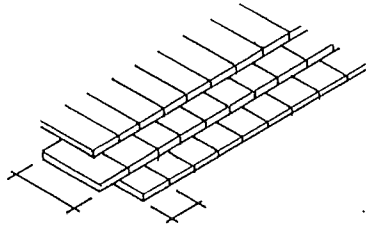

**Acceptable:**  
3/8" thick taper-sawn cedar shingles with  
4 ½ to 5 ½ weather

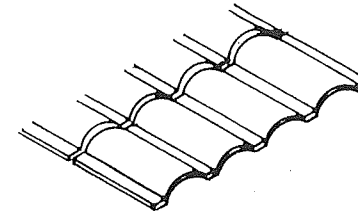

**Not Appropriate:**  
Clay Tiles or simulated tiles

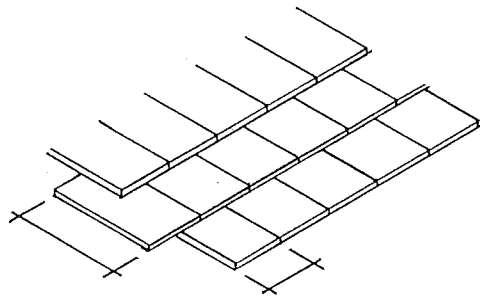

**Acceptable in Certain Situations:**  
Cedar Shakes—for barns only

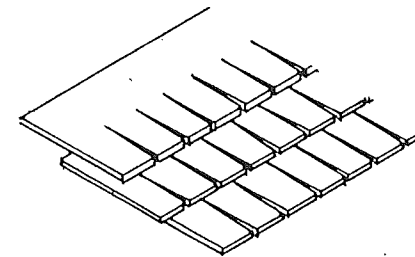

**Acceptable:**  
Asphalt shingle of traditional size, colour,  
texture and weather

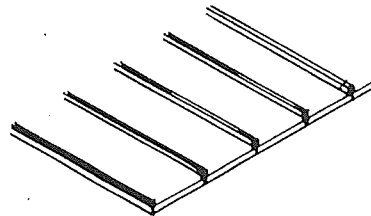

**Acceptable in Certain Situations:**  
Wood board and batten—for porch roofs

## 9.4 New Buildings

---

### 9.4.2.11 Roofs: Flashing

#### Guidelines

Where a roof meets a wall, highly visible flashing connections should blend in with the wall colour. Stepped flashing and caulking should not be highlighted by matching their colour to the trim of the house (e.g., white, beige, etc.). Such flashing should be coloured to match the wall against which it is located.

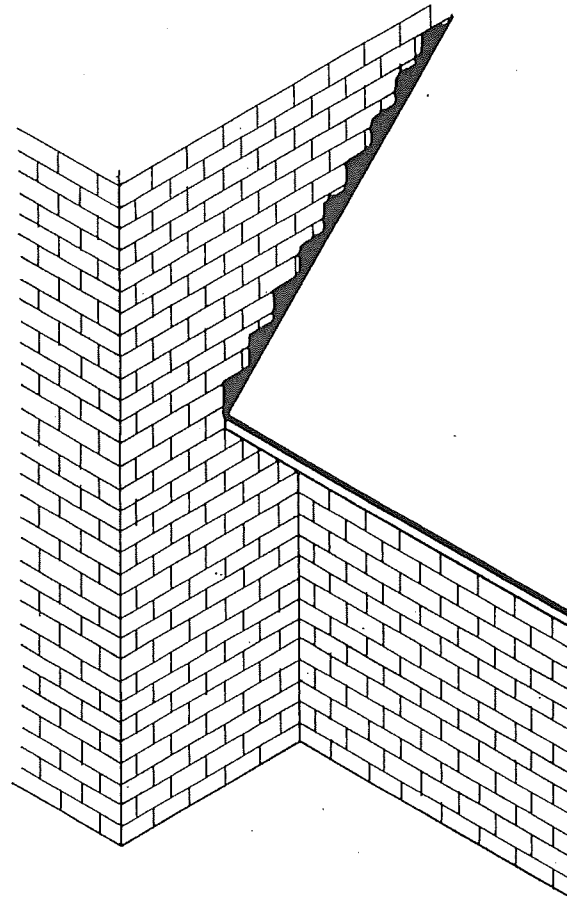

Flashing colour should blend, not contrast.

## 9.4 New Buildings

### 9.4.2.12 Dormers: Appropriate Styles

Although not extensively found in the District, the use of appropriately scaled dormers can be a positive addition, as opposed to skylights which should be avoided on the public façades of a new building. Similarly, stacks, vents, etc., should all be located on the less public side of a structure.

The traditional purpose of dormers was to bring light, not space, to an attic room. The extension of the dormer beyond the width of the window trim should be negligible.

#### Guidelines

1. Dormers in new construction should be consistent with the style of the house and should be consistent with traditional dormer scale and proportions.
2. Dormers should reflect the traditional hierarchy of windows on a structure, in that the windows in the dormer should be of a lesser scale than the windows on the lower part of the building.
3. The predominant type of dormer in the district is the roof dormer.

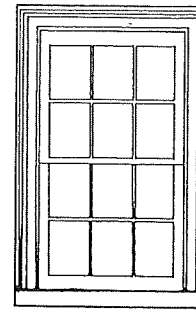
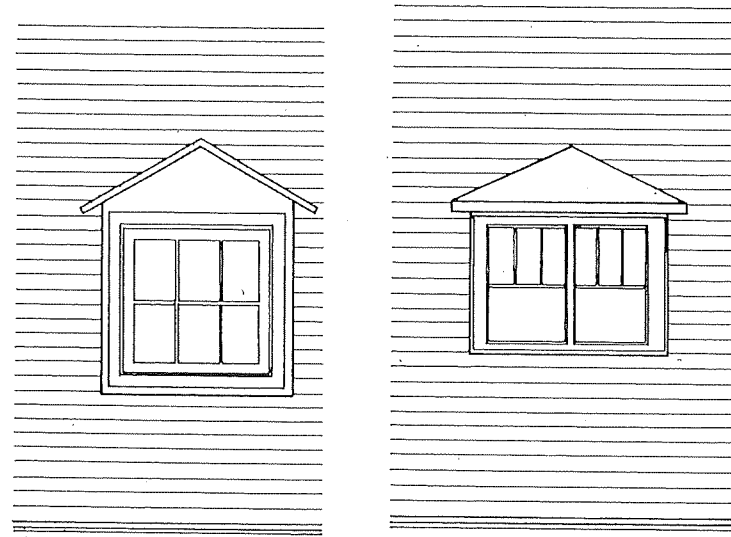

A Georgian dormer and its corresponding window

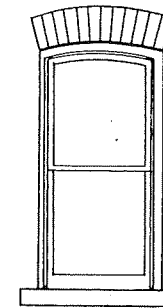

An Edwardian Classicism dormer and its corresponding window

## 9.4 New Buildings

### 9.4.2.13 Dormers: Inappropriate Styles

The windows in the dormer should reflect the style of the building and be smaller in size than the main windows on the building.

#### Guidelines

1. Dormers should be proportioned in a traditional manner with the window, rather than the wall, as the dominant feature.
2. Dormers should not overwhelm the proportions of the façade. Simple dormers are preferred.
3. Double dormers should be avoided.
4. Palladian windows and other features which draw attention to the dormers are not appropriate.
5. Generally, dormer windows should be double hung in appearance.
6. Skylights on the visible façades of a building should be avoided.

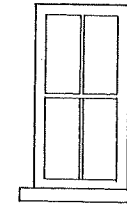
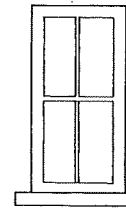
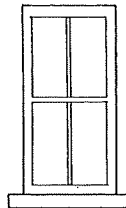
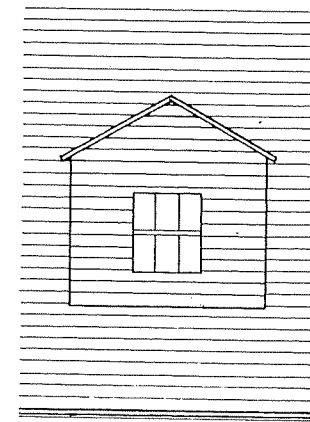
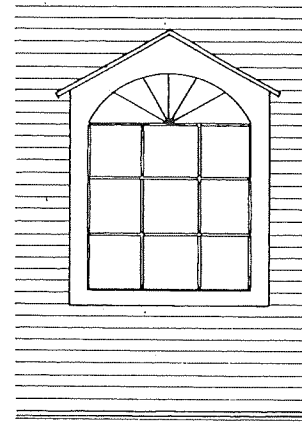
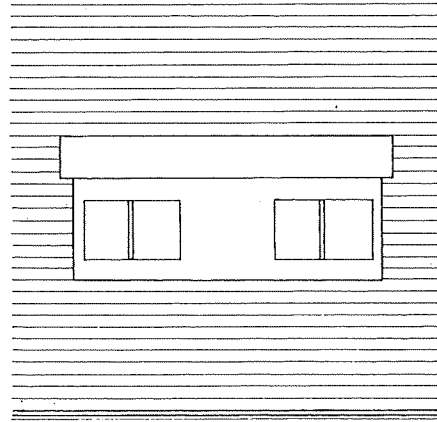

Double dormers and shed dormers should be avoided.

Dormer size is excessive; doesn't relate to original window; dormer window is overly complex.

Dormer size is excessive; window is too small for dormer.

## 9.4 New Buildings

### 9.4.2.14 Windows: Appropriate Styles

The predominant historic window type in the District is wood, double hung, which is characterized by two vertically sliding sashes, each closing a different part of the window. The double-hung window form can include both flat headed and segmental arched designs. Pane division variations include the 6/6 (six panes on top of six panes), 1/1, and 2/2, which are most prevalent.

The demand for heritage-friendly construction has improved the visual quality of many products including non-wood windows.

#### Guidelines

1. Windows on new construction should visually reflect the historic windows in the District (double- or single-hung windows) and be consistent with the style of the house.
2. A consistent approach to window proportion and type should be followed in the design of a new building.
3. As a general principle, windows should be taller than their width (usually 2:1 ratio of length to width).
4. The use of traditional wood windows in historical configurations and profiles is always preferable.
5. Windows made from more modern materials in historical configurations and profiles that visually give the appearance of a wood window may be used. Consultation with staff will be required.

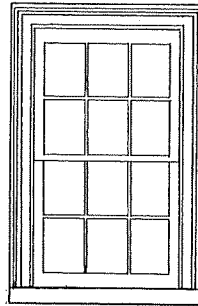

6/6 Double Hung:  
Square Headed

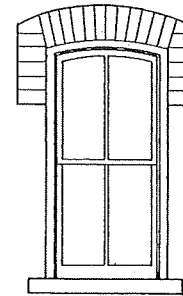

2/2 Double Hung:  
Segmental Arched

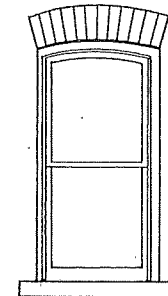

1/1 Double Hung:  
Segmental Arched

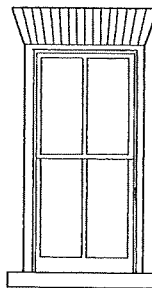

2/2 Double Hung:  
with angled brick voussoirs

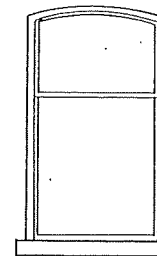

1/1 Transom Window

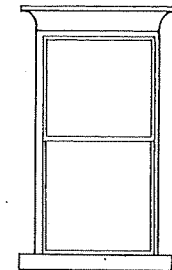

1/1 Double Hung:

## 9.4 New Buildings

---

### 9.4.2.15 Windows: Accent Windows

While the predominant window types in the District are double hung, flat, or segmental arched, there are some accent windows usually in gables.

#### Guidelines

1. Accent windows used in new construction should reflect those found in the District and be consistent with the style of the building.
2. Stock suburban accent windows are not appropriate.

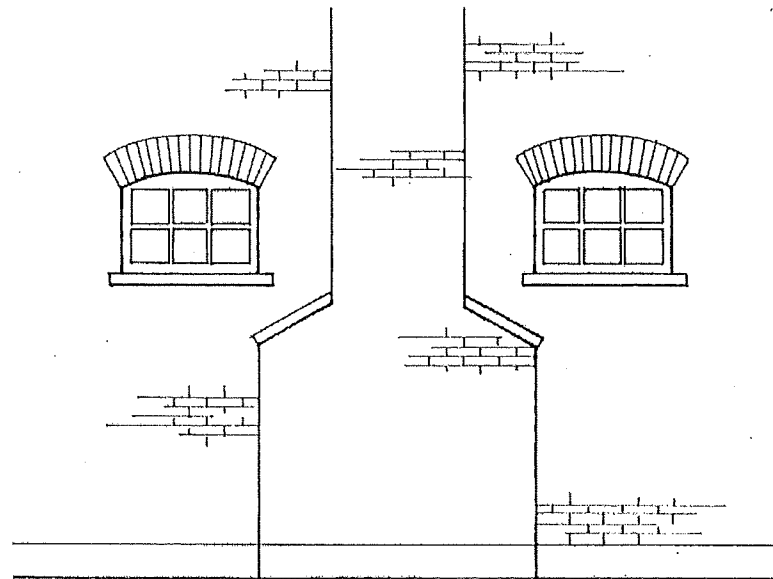
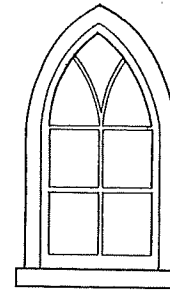

Gothic accent window sometimes used in the centre gable of Ontario Classic houses (above).  
Accent windows flanking the fireplace, as used in Arts and Crafts houses (below).

## 9.4 New Buildings

---

### 9.4.2.16 Skylights

Skylights or roof windows are not consistent with the heritage character of the District and are to be avoided on the visible elevations of buildings (e.g., the front and sides).

#### Guidelines

1. Where skylights or roof windows are used they should be flat, projecting only a minimal distance from the roof, tinted to match the colour of the roof; and placed in locations on the roof that are least visible.
2. Skylights or roof windows are not appropriate on elevations of the building generally visible from the street.
3. Bubble skylights are not appropriate for use in the District.

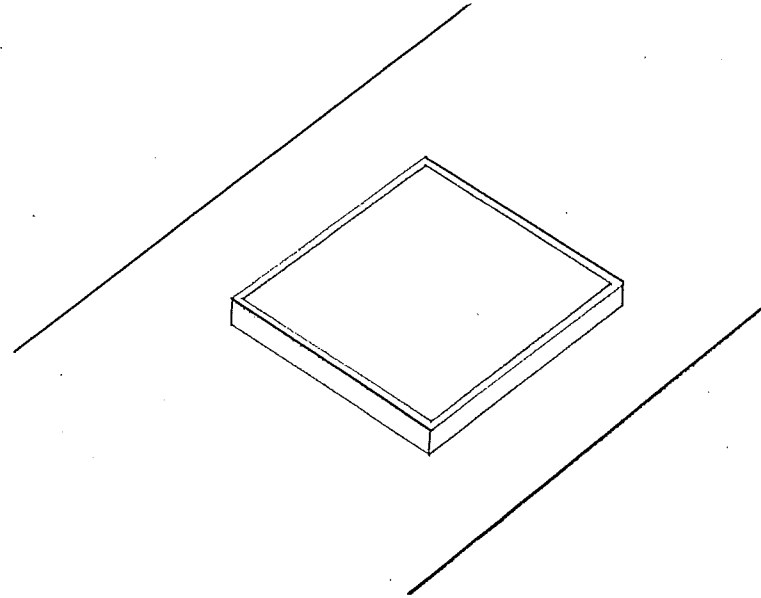

Where skylights are permitted they should be flat, of the same colour as the roof, and placed in locations that are least visible.

## 9.4 New Buildings

### 9.4.2.17 Windows: Bay Windows

Typical features of the historic bay windows include:

- simplicity in detailing;
- large wood mullions or a brick course between the windows;
- double-hung windows;
- the bay extends to the ground;
- ordered placement on the façade.

#### Guidelines

1. The use of a bay window should be appropriate for the architectural style of the building.
2. Bay windows on new construction should be applied in an orderly manner, extend to the ground and reflect historic bay window forms.
3. Popular modern bay windows such as those with minimal mullions, multi-paned casement windows, or which do not extend to the ground are not appropriate.

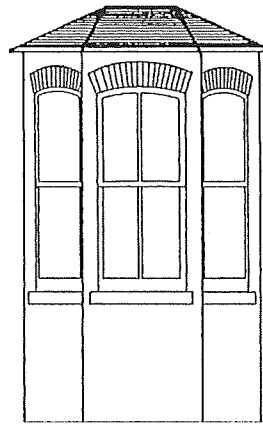

**Appropriate:** typical historical brick bay window

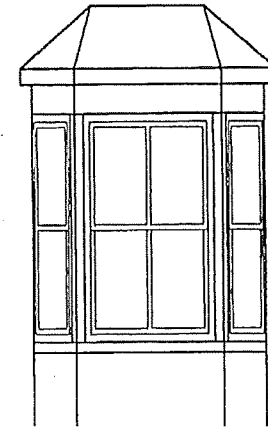

**Appropriate:** typical historical wood bay window

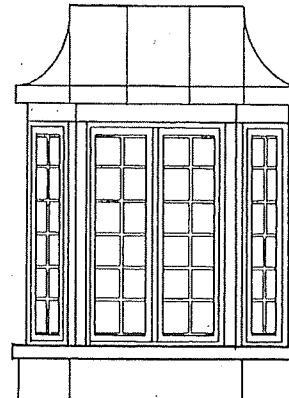

**Not Appropriate:** elaborate, suburban type bay window with multi-paned casement

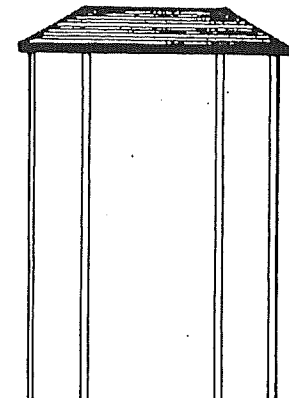

**Not Appropriate:** fixed bay window with minimal mullion bars which does not extend to the ground



## 9.4 New Buildings

### 9.4.2.18 Windows: Inappropriate Styles

These windows tend to be overly elaborate or are not compatible with the traditional architecture of the District. Windows should feature traditional forms and articulation.

#### Guidelines

1. Windows on new construction should reflect the historic windows in the village. Non-traditional window configurations should be avoided.
2. Stock window forms, typical of modern suburban design are not appropriate in the District.
3. New windows should reflect the tradition of simplicity in the District. Overly elaborate windows are not generally appropriate.
4. Divided windows should include real, externally perceivable muntin bars (external, permanently adhered muntins are also acceptable).
5. Window screens that are visible from the exterior should be avoided.

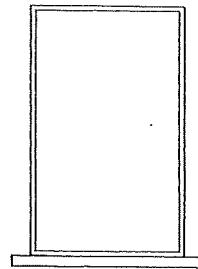

Fixed pane

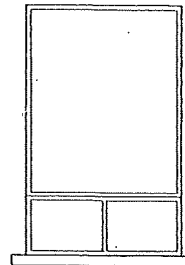

Fixed sliding window

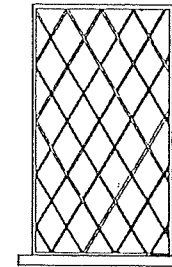

Diagonal muntin bars

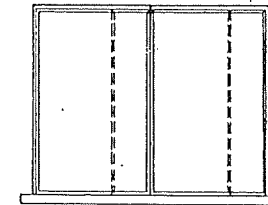

Sliding windows

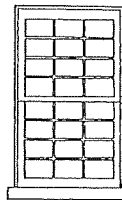

Panes wrong shape



Horizontal windows

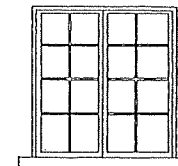

Casement windows

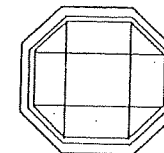

Hexagonal or round windows

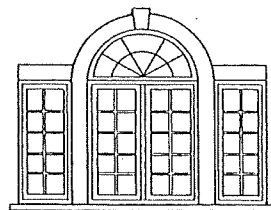

Compound casement Palladian

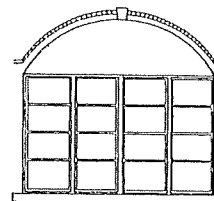

Multi-casement, flat head window, exaggerated arch

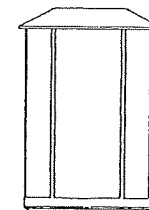

Unarticulated fixed pane hanging glass bay

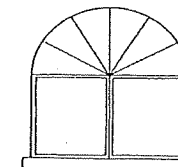

Stock fan window over casements

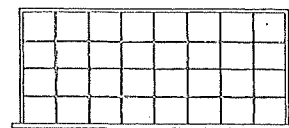

Large horizontal fixed pane



Too narrow and vertical transom should be avoided

**Windows illustrated are to be avoided**

## 9.4 New Buildings

### 9.4.2.19 Windows: Muntin Bars

Muntin bars are the framing members used to hold panes within a window or glazed door and are typical features in Thornhill. Windows are considered to be “the eyes of a house” and are among the most important visual features. The diffusion of light created by externally perceivable muntin bars on windows is a significant contributor to the appearance of the heritage building stock.

For new construction, where a “divided window look” is proposed, the use of true divided windows with real muntin bars is encouraged. Some window manufacturers produce windows with imitation muntin bars which snap in behind the glass. This approach should be avoided, since the pane divisions do not appear real and the diffusion of light is not evident.

Where muntin bars are proposed, it is important that the type of bar division be compatible with the style of the house and appropriate to the District.

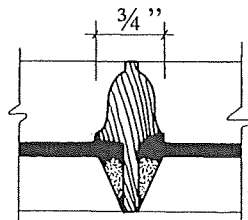
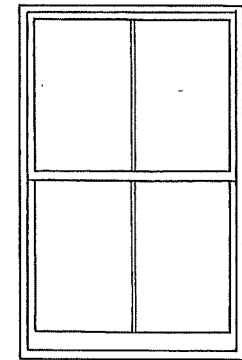
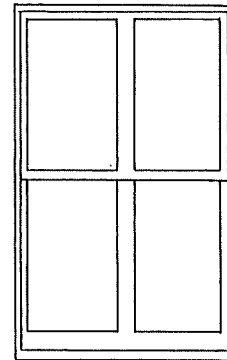
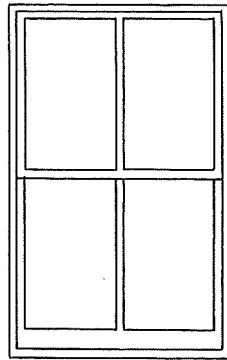

Appropriate thickness

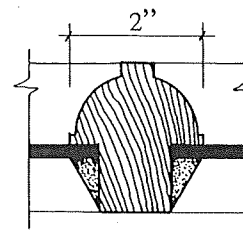

Too thick

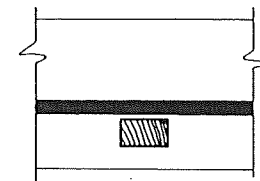

Snap in muntin bar:  
profile too thin and not  
perceived externally

## 9.4 New Buildings

### 9.4.2.19 Windows: Muntin Bars cont'd

Pane divisions such as 4/4 (four panes over four panes), 6/9, and 3/3, or diagonal divisions, are not found in the District and should be avoided.

It is also important that the size and profile of the muntin bars should be consistent with the traditional size that would have been seen historically in the District.

#### Guidelines

1. Where divided windows are proposed on windows readily visible to the general public, they should consist of true divided lights (externally perceivable muntin bars) or muntin bars that are externally, adhered to the outside glass.
2. Snap-in muntin bars are not supported.
3. The type of muntin bar division should be compatible with the architectural style of the house.
4. Muntin bar divisions that would not have historically appeared in Thornhill should be avoided.
5. The size and profile of muntin bars should be compatible with the typical historic varieties used in the District.

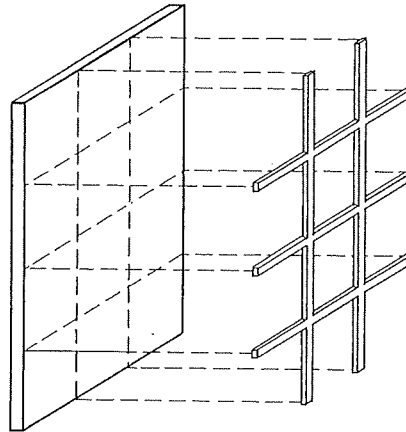

Snap-in imitation muntin bars to be avoided

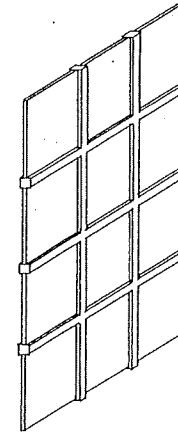

True divided wooden muntin bars encouraged

## 9.4 New Buildings

### 9.4.2.20 Windows: Storm Windows and Double-glazed Windows

If muntin bars are necessary for a particular design, and thermal efficiency is also an important consideration, thermally sealed double-glazed windows can be acquired with real muntin bars.

On historic buildings and elsewhere, when authentic single-glazed lights are necessary, comparable thermal efficiency may be achieved through the use of traditional wood storm windows.

When adding storm windows to the external face of a window, the pane division of the storm window should match the pane division of the original window. When adding storm windows to the internal face of a window, the pane division of the storm window should either match the pane division of the original window or it should have no divisions at all.

#### Guidelines

1. When using storm windows, those selected should be of compatible size, material, and pane division compared to the host window.
2. If thermal or double-glazed windows are used, they should possess externally perceivable muntin bars of a size and profile compatible to the architectural style of the building.



Appropriate: 2/2 storm window added externally to 2/2 original window

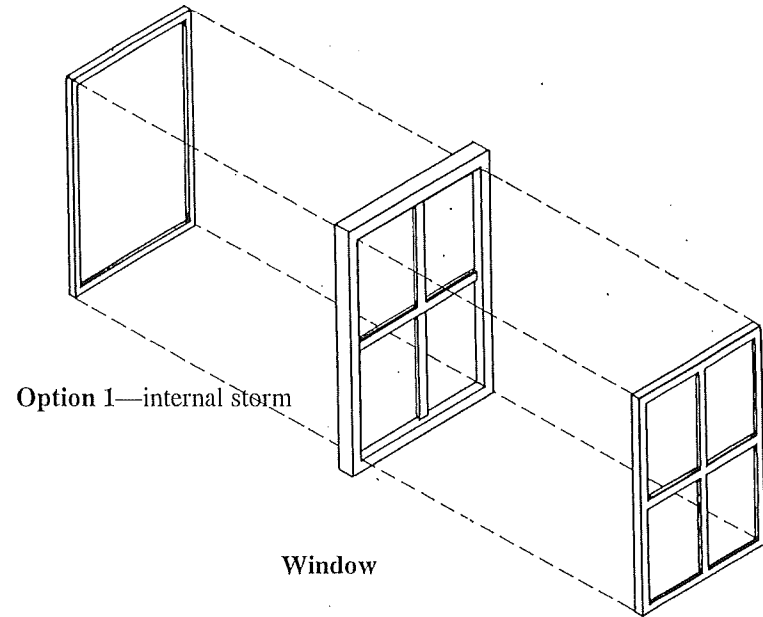

Option 2—external storm

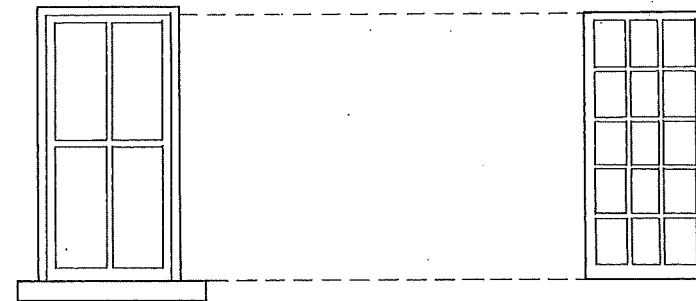

Inappropriate: multi-paned storm window added externally to original 2/2 window

## 9.4 New Buildings

### 9.4.2.21 Windows: Shutters

Shutters are movable screens, usually made of wood, used to provide additional screening for openings in a building. The most common types are external louvered shutters which are attached to hinges on the frame of the window.

Although today they serve more as decoration, shutters were important functional components of the house as sun and wind shields and insulators, and this was reflected in their design. Shutters had to be able to fully close over an opening thus the width of shutters was invariable equal to half the width of the window.

#### Guidelines

1. Shutters should be half the width of a window and attached at the frame, not the wall, in order to appear functional.
2. Shutters should be of louvered construction and fit the window shape and size.
3. The use of traditional shutter hinges is encouraged.
4. The use of wood shutters is preferred. Shutters made from more modern materials may be used. Consultations with staff on the appropriateness will be required.

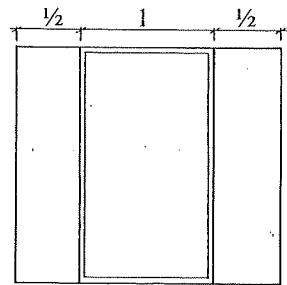

Shutters should each be  $\frac{1}{2}$  the width of the window.

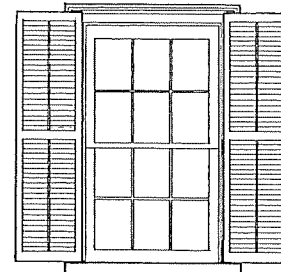

Square shutters fit square-headed windows.

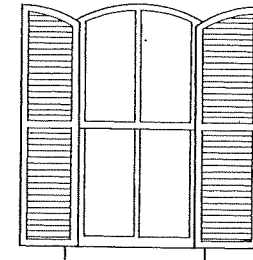

Segmental arched shutters fit segmental arched windows

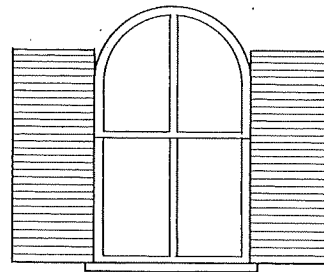

Shutters do not fit the shape of the window

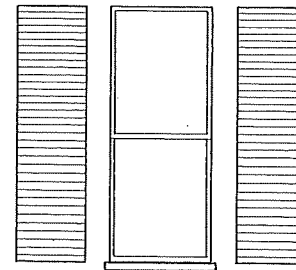

Shutters are fixed to the wall, do not appear functional.

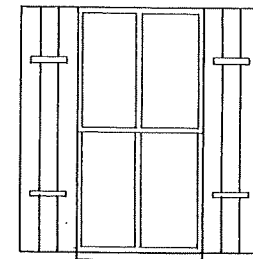

Board, panel, or solid shutters were not a common historic feature in Thornhill, and should be avoided.

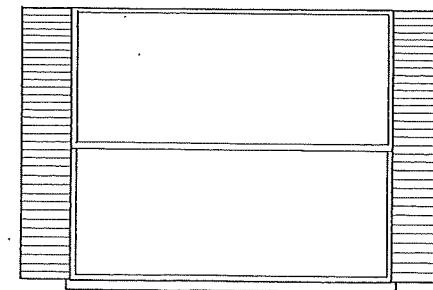

Shutters inappropriate for window

## 9.4 New Buildings

---

### 9.4.2.22 Window-to-Wall Ratio

The window-to-wall ratio is measured by the amount of window space against the amount of wall space on each façade. Heritage buildings in the District have a window ratio of 15–20% of the total wall coverage.

#### Guidelines

1. New construction should respect the traditional ratio of 15–20% of window-to-wall coverage.
2. Greater window-to-wall ratios should be avoided.

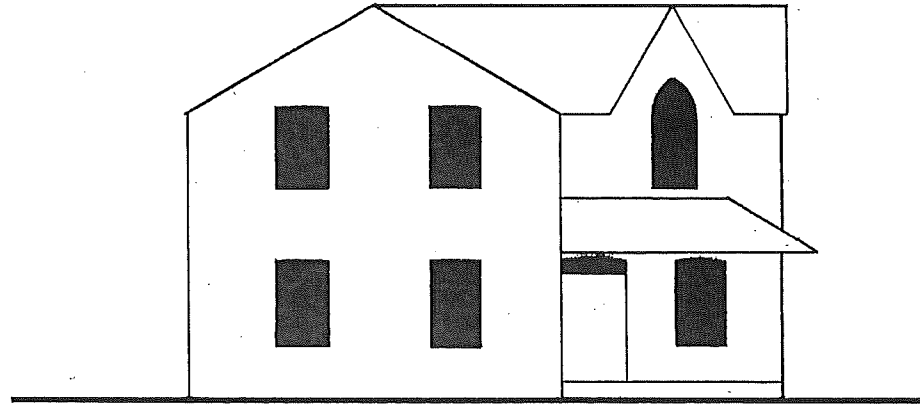

Appropriate: 15 to 20% is historically accurate.



Not Appropriate: 40% is excessive.

## 9.4 New Buildings

### 9.4.2.23 Window and Door Placement

In the historic architecture of Thornhill, buildings were usually designed with an orderly placement of windows and doors on the façades, while in modern suburban architecture, often the façade is secondary. New construction should respect the historic patterns of window and door placement within the District.

In the District, window placement may vary slightly from period to period, but in no case do windows appear at ceiling height, touching the roof in elevation. This should be respected when placing windows in new construction.

#### Guidelines

1. On façades that are visible from the street, new windows should maintain historic proportions and placement patterns found prevailing in the District.
2. Where appropriate, centre lines of windows should be aligned vertically.
3. Windows should have sufficient clearance around all sides to avoid a cramped appearance.
4. Windows on new buildings should not touch the eave.
5. A door should be visible on the front façade and placed in a traditional manner.

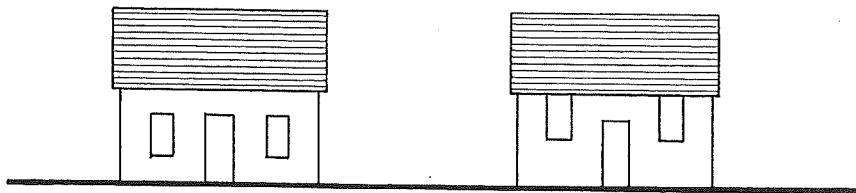

Ordered: Windows are balanced vertically on the façade.

Disordered: Windows appear cramped when placed directly under the eaves.

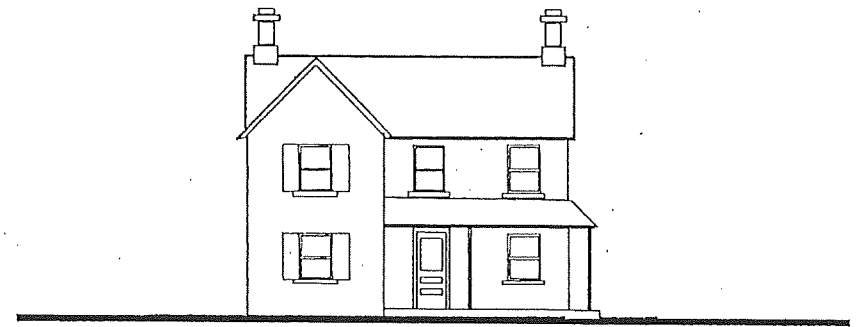

**Ordered Façade:** Compatible with the Heritage District

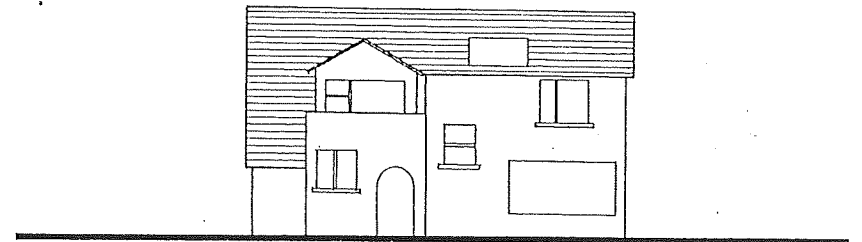

**Disorganized Façade:** Not compatible with the Heritage District

## 9.4 New Buildings

### 9.4.2.23 Window and Door Placement cont'd

6. Where internal arrangements such as a kitchen counter impact the ability to achieve a proportioned and/or symmetrical façade, the use of an internal ledge can help to achieve symmetry.

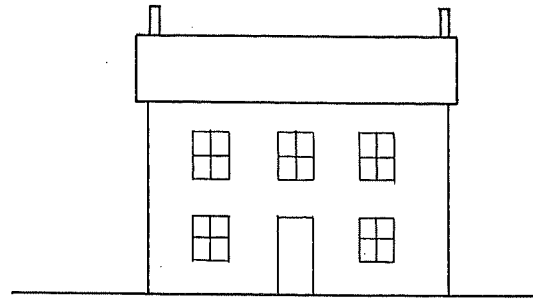

**Elevation:** appropriate window treatment—Symmetry is maintained.

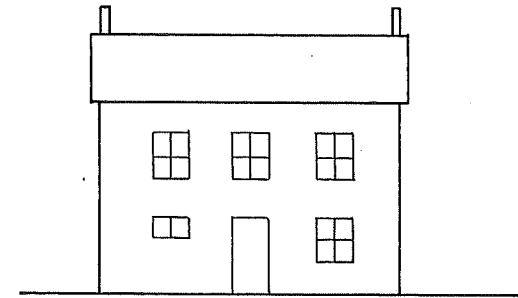

**Elevation:** exterior appearance is affected due to internal feature. Symmetry is lost.

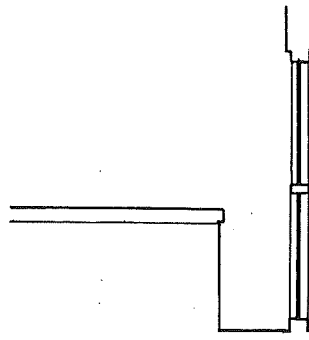

**Section of window above:** Use of ledge preserves symmetry.

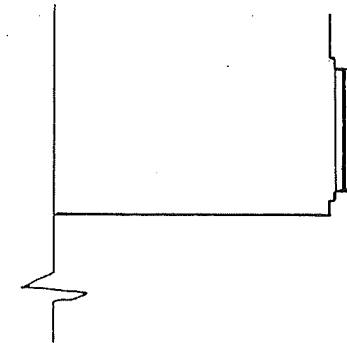

**Section of window above:** No use of ledge compromises symmetry..



## 9.4 New Buildings

### 9.4.2.24 Doors: Appropriate Styles

The historic doors of Thornhill are typically made of wood and were consistent with the styles popular in Ontario in the 19<sup>th</sup> and early 20<sup>th</sup> century.

The earliest and most widely used of the historic doors is the wood panel door. Varieties include the square-headed four panel, round-headed four panel, and the cross-and-bible, distinguished by four upper panels which are positioned to resemble a cross and the two lower panels, said to represent an open bible.

Other door types include the partially glazed door, which is popular in late 19<sup>th</sup> century residential and commercial buildings, the double door (each of which is typically  $\frac{3}{4}$  the size of a standard door), and the vernacular solid wood outer door.

#### Guidelines

1. An appropriate style of door should be selected consistent with the proposed architectural expression.
2. The door should maintain the existing proportions and reflect the designs found prevailing in the District.
3. The use of a traditional wood door is preferable; however, doors constructed from modern materials that give the appearance of a wood door may be used.

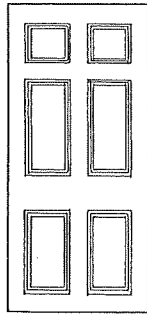

Cross and Bible panel door

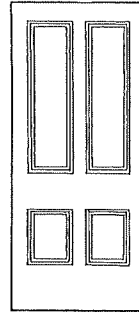

Four panel door

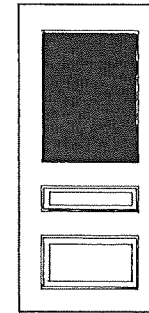

Half-glazed door

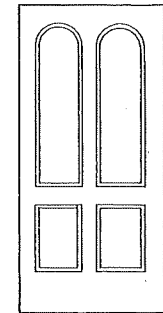

Round-headed four panel door

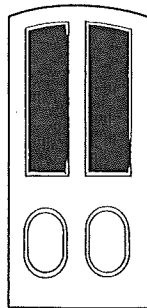

Partially glazed panel door

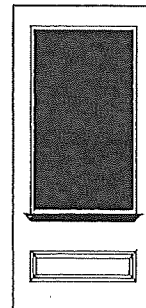

$\frac{3}{4}$  glazed door

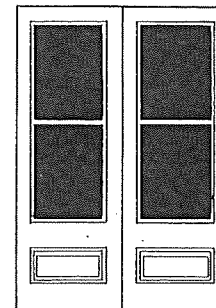

Paired  $\frac{3}{4}$  glazed doors

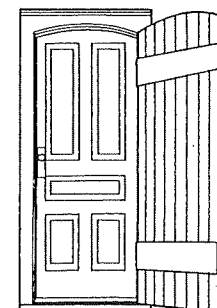

Panel door with solid wood outer door

## 9.4 New Buildings

### 9.4.2.25 Doors: Inappropriate Styles

Doors are significant elements in the elevation of any building. In order to ensure compatibility with the character of the District, new doors should reflect the designs, colours, and textures commonly found on local heritage buildings.

#### Guidelines

Stock modern doors of compositions and materials that are not consistent with the character of the District should be avoided.

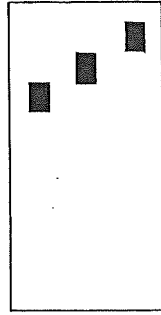

Inappropriate design and proportion

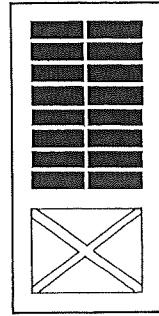

Not a traditional Thornhill design; inappropriate pane division; stock modern door

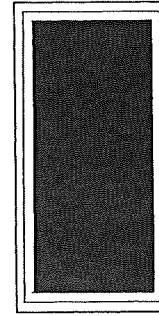

Overglazed

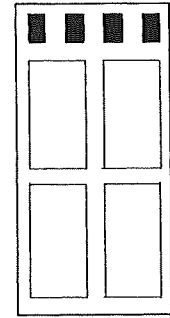

Inappropriate design and proportion

## 9.4 New Buildings

### 9.4.2.26 Doors: Frames and Surrounds

In the historic doors of Thornhill, the proportion and amount of glazing in the door surround was usually related to the design of the door itself. Typically when there was glazing in the door, sidelights were not seen and when sidelights were applied, they were either installed in pairs or not at all. Sidelights and transoms are most often typified by glass that is divided by true divided muntin bars, rather than single-glazed panels.

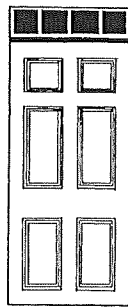

**Appropriate**  
Square Transom,  
no sidelights

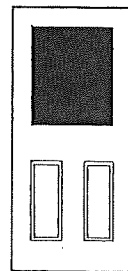

**Appropriate**  
Door with window,  
no sidelights

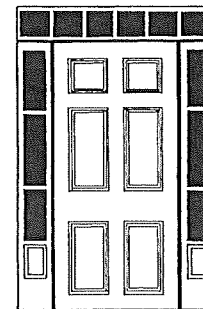

**Appropriate**  
Traditional door, with  
transom and sidelights

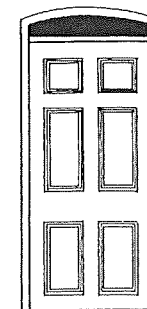

**Appropriate**  
Rounded transom  
no sidelights

#### Guidelines

1. The door surround should be appropriate for the architectural style of the building.
2. Door surrounds should be consistent with the traditional design of these elements seen in the District.
3. Sidelights should be used in pairs and only where the door is not glazed.
4. The lower ¼ of the sidelight should be a solid panel.

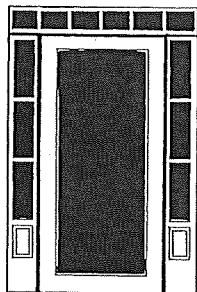

**Not Appropriate**  
Glass door with  
transom and sidelights

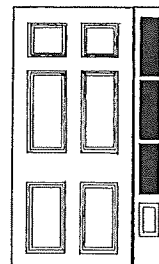

**Not Appropriate**  
Single sidelight

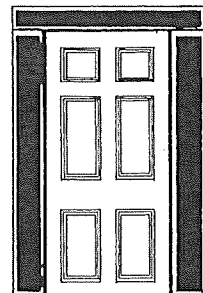

**Not Appropriate**  
No articulation of  
sidelights and transom

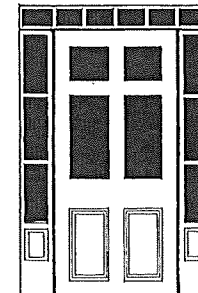

**Not Appropriate**  
Glass in door with  
with sidelights/transom

## 9.4 New Buildings

### 9.4.2.27 Foundations

The early foundations in the District were almost entirely built of fieldstone. With improvements in concrete technology around the turn of the century, concrete gradually replaced stone as the material of choice. Foundations are visually evident in the architecture of the village, but tend to be relatively low.

#### Guidelines

1. Foundations on new construction should be of a height that is appropriate to the historic architectural forms of the District.
2. Any increase in window size in the foundation should be incorporated through a window well rather than extending the foundation out of the ground.
3. Where new construction occurs in areas of particular sensitivity or the foundation will be highly visible, exposed foundation walls above grade should have a rebate to be faced with split-faced, coursed random rubble laid to appear structural, as in a traditional fieldstone foundation, or cultured stone with a similar appearance. The stone should be of mixed colours and types representative of locally found fieldstone. The stone should not be laid in a flagstone pattern resembling modern stone veneering.

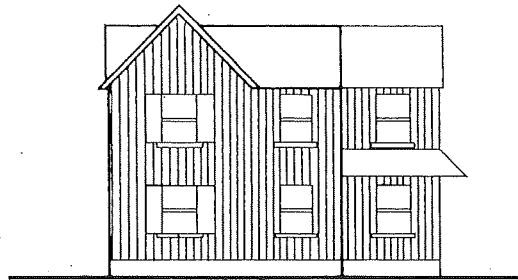

Traditional foundation

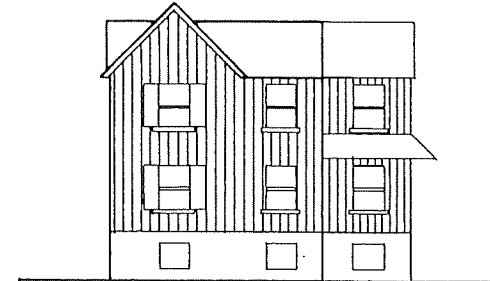

Excessive foundation

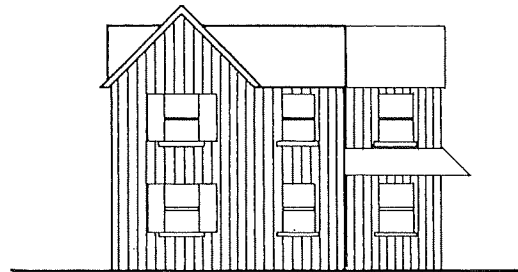

Lack of foundation

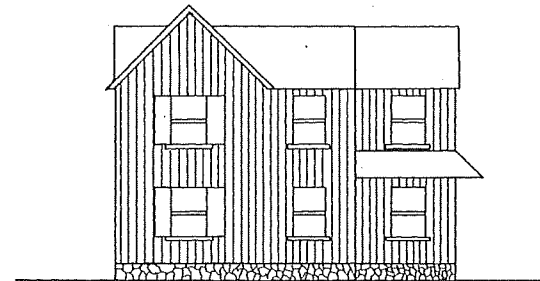

Stone-clad foundation

## 9.4 New Buildings

### 9.4.2.28 Wall Cladding Materials

In the case of new construction, the selection of building materials should reflect the context of the particular site. Not only is it important to make a selection based on what is fitting for the design of the new building, but also if it is appropriate for its specific locale. For example, all of the heritage buildings on Colborne Street are of frame construction.

Materials used as exterior finishes for any new structure should be visually compatible with the adjacent historical buildings. Traditional cladding materials in Thornhill include:

- Stucco : Rough Cast
- Brick : Red Clay
- Wood : Vertical Wood  
: Horizontal Clapboard  
: Board-and-Batten

Stone is used as a foundation material, but not a wall material. The only type of stone used is coursed split fieldstone, laid horizontally, which reflects its function, and is fully dressed.

#### Stucco:

Thornhill is the one area of Markham where dwellings were commonly clad in a rough-cast stucco.

#### Wood:

Wood sidings are the most common cladding material used in the District. Pre-1867 structures used horizontal 4–5" weather board and board-and-batten, while post-1867 structures used more narrow horizontal siding or vertical wood.

#### Brick:

Traditional bricks were 8½" long by 2½" high and reddish in colour.

When choosing materials it should be considered that brick tends to exhibit a more dominant appearance than wood and may not necessarily be appropriate for all contexts within the District.



The varied but compatible distribution of historic building materials is an important contributor to the District character.

## 9.4 New Buildings

### 9.4.2.28 Wall Cladding Materials cont'd

#### Guidelines

- The materials used in new construction should be compatible with the historic materials used in the District as well as the specific design of the proposed building.
- The use of traditional wood sidings is always preferable. Non-traditional materials and products, such as vinyl and aluminium, in historical configurations and profiles that provide the appearance of traditional sidings may be used. Consultation with staff is required.
- Brick should be of the standard older, Ontario Size variety (no greater than 2½" by 8½"), and of a traditional local colour and texture. CSR size brick is also acceptable. The use of traditional mortar colour, profile, and texture is encouraged.
- Stone is appropriate for foundations only.
- Cladding materials that are not appropriate include: concrete block, concrete brick, pre-cast or poured concrete panels, ceramic tile, angelstone, smooth stucco, wood shakes, insulbrick, artificial stone, and terra cotta.

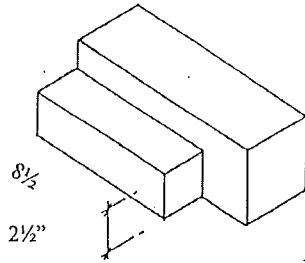

**Appropriate:** Ontario sized brick (traditional)  
**Not Appropriate:** oversized brick

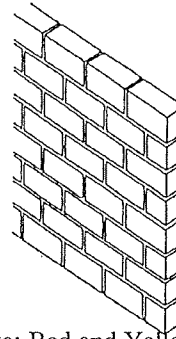

**Appropriate:** Red and Yellow clay brick consistent with historic local varieties

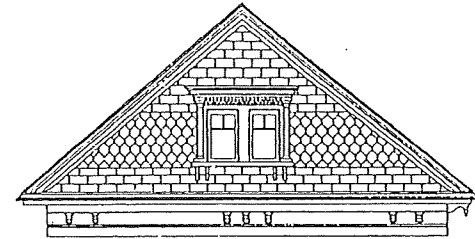

**Appropriate:** Wood shingles on Queen Anne Style gables and on Bungalow Style.

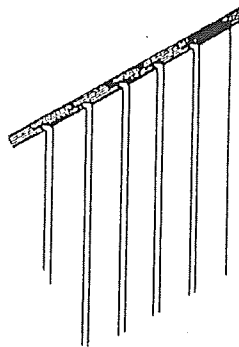

**Appropriate:** tongue and groove wood siding

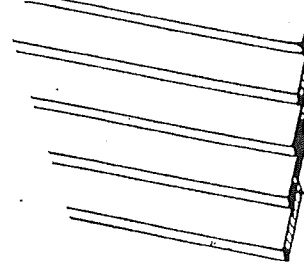

**Appropriate:** 4" horizontal wood clapboard

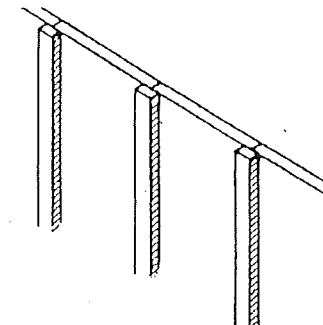

**Appropriate:** Vertical wood board and batten siding

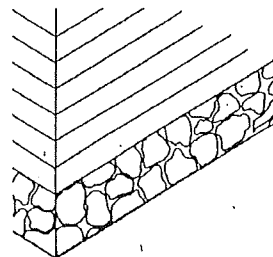

**Appropriate:** Stone—  
for foundations only

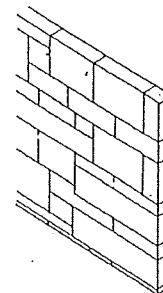

**Not Appropriate:** Stone or horizontal Angelstone

## 9.4 New Buildings

---

### 9.4.2.29 Architectural Details: Brick

One of the common misconceptions with regard to new development in historic areas is the use of decorative polychromatic (two-toned red and buff or yellow coloured) brick detailing.

Typically in Thornhill, polychromatic brickwork was applied sparingly and was significantly more subtle than seen elsewhere in Ontario. If it was applied, it was used so in the voussoirs over the windows and as mock quoins at the corners of the building. It was not applied beneath or at the sides of windows (though occasionally there might be a slight overhang in a segmental arch).

#### Guidelines

Polychromatic brick detailing should be applied only when stylistically it is appropriate and should reflect the tradition of simplicity that is seen in Thornhill architecture.



St. Volodymyr's Rectory on Church Lane shows banding (not soldier coursing!), quoining, and voussoirs in contrasting brick.

## 9.4 New Buildings

### 9.4.2.30 Architectural Details: Voussoirs

The purpose of a lintel is to support the masonry above an opening. Traditional 19<sup>th</sup>-century window and door openings were supported on a stone lintel that extended beyond the opening or by a brick or stone arch, made up of angled masonry which carried the loads to the wall alongside. The angled masonry units are called voussoirs.

Most modern openings are supported on hidden steel lintels, so the masonry no longer carries the loads. As a result, brickwork can be installed in a way that does not replicate the historic form where the lintel must extend beyond the opening to bear on the wall below. Vertical soldier courses that don't extend beyond the opening don't appear functional, and look false and trivial.

#### Guidelines

On brick buildings, traditional angled voussoirs should be constructed above the windows and doors. Soldier-course lintels and wood pediments should be avoided.

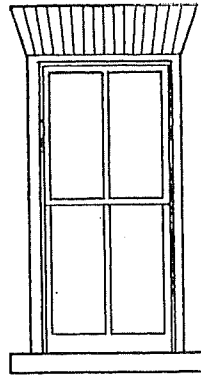

Correct

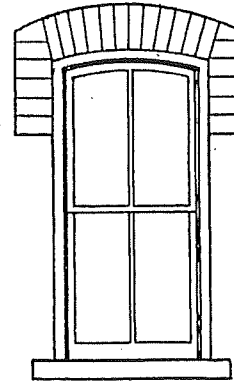

Correct

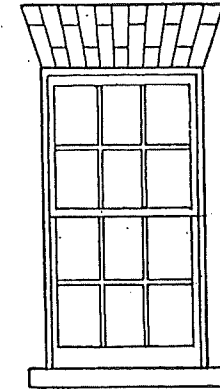

Correct

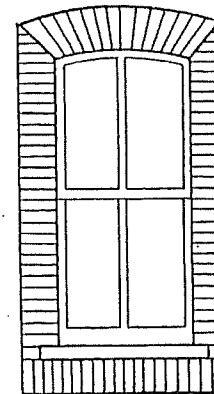

Incorrect

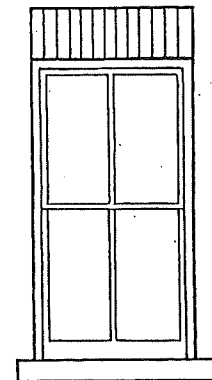

Incorrect



## 9.4 New Buildings

### 9.4.2.31 Architectural Details: Keystones and Sills

Keystones are architectural details used as an accent in door and brick surrounds. While often seen in major centres, such as Toronto, and in modern suburban construction, in simple historic Thornhill architecture, keystones are not a typical feature.

Window sills in the District were historically made from wood, and later from stone and concrete. On masonry structures, the use of a contrasting material served to highlight the window opening. The trend in modern construction is to use brick sills. Unfortunately, the detail is often lost within the wall and as a result, the appearance of the window is diminished.

#### Guidelines

1. Keystones and other overly elaborate architectural details should not be used.
2. Window sills should be made of wood, stone, or concrete; brick sills should not be used.
3. All windows should have sills.

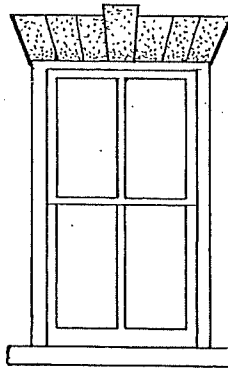

**Not Appropriate:** elaborate concrete lintel, keystone oversized

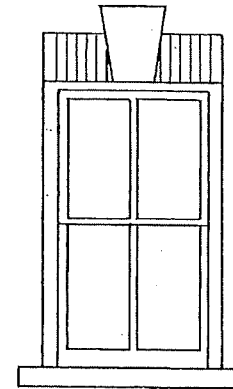

**Not Appropriate:** keystone oversized, lintel is soldier course

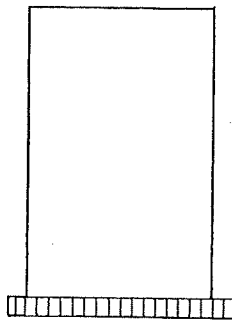

**Not Appropriate:** brick sill

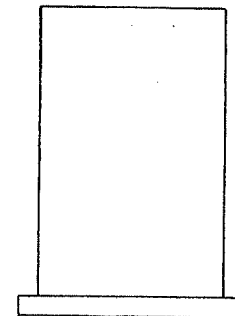

**Appropriate:** stone sills or wood sill preferred, concrete post-1900 styles, wood pre-1900 styles

## 9.4 New Buildings

### 9.4.2.32 Architectural Details: Brick Quoining

Quoining is based on an historic practice of using hard stone or brick to reinforce the external corner edge of a wall.

The historic roots of quoining were apparent to builders in the 19<sup>th</sup> century, who typically constructed the feature in a functional manner. They employed an alternating pattern, whereby the multichrome brick would be continually present on the façade.

A typical misrepresentation of quoining which appears in modern construction is the separation of the quoins. This practice, unfortunately, diminishes the functional appearance of the quoins and also the compatibility of a building within the heritage area.

#### Guidelines

1. Where quoining is to be used on buildings of a pre-20<sup>th</sup> century style, traditional quoining techniques should be used.
2. Brick quoins do not necessarily have to be a different colour than the wall (e.g., buff quoins in a red brick wall).

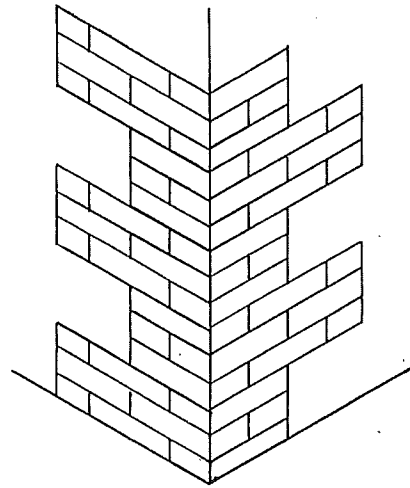

**Appropriate:** This quoining technique is historically accurate, and seen most often in mid-to late- 19<sup>th</sup> century styles (c. 1860 to 1900)

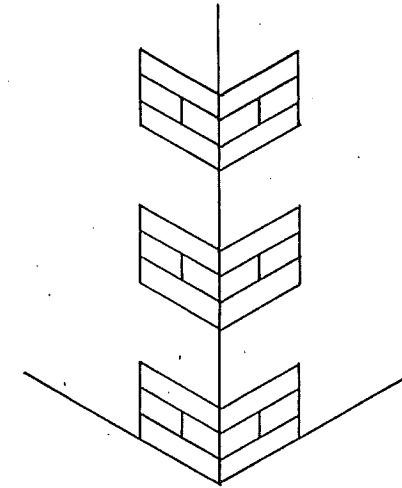

**Not Appropriate:** This quoining technique is not historically accurate in the context of Thornhill

## 9.4 New Buildings

### 9.4.2.33 Architectural Details: Brick Coursing

A brick course is a horizontal row of bricks that circles the entire building or a portion of it. It forms a pattern, such as a line or multiple crosses, and is done in contrasting colours.

Contrary to some modern representations of brick coursing, in traditional architecture the bricks tended to be laid with the run of the bricks in the wall rather than perpendicular in soldier course (which would not have been structurally stable using traditional masonry techniques).

#### Guidelines

1. Brick coursing should reflect traditional local examples with respect to pattern, alignment, and colour.
2. Soldier-course banding is not appropriate.

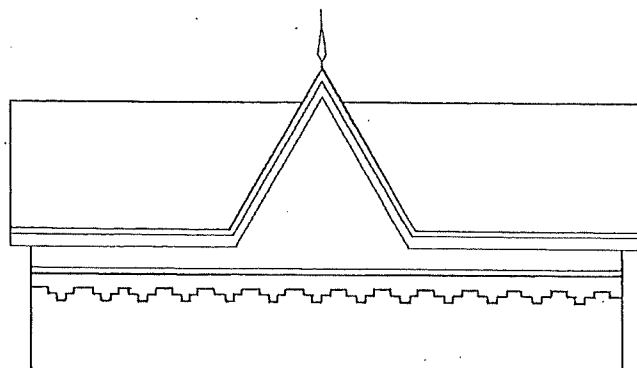

**Appropriate:** historical coursing, using cross pattern in running bond.

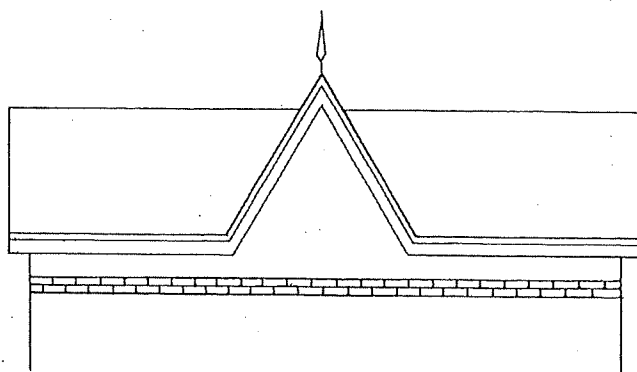

**Appropriate:** simple coursing, running bond

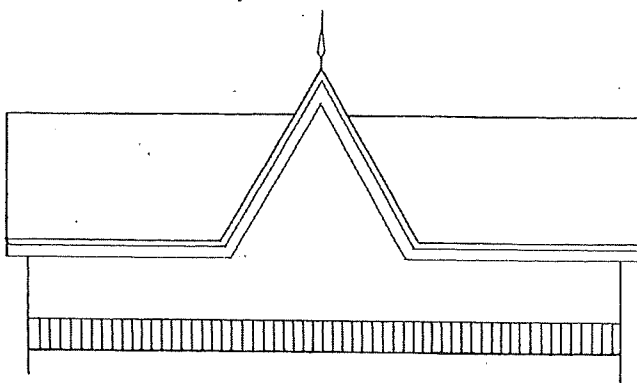

**Not Appropriate:** vertical soldier brick coursing

## 9.4 New Buildings

### 9.4.2.34 Architectural Details: Porches and Verandas

Porches are semi-enclosed spaces applied to buildings which provide a means of shelter. In stylistic terms, a “porch” provides a relatively small amount of cover, while a “veranda” extends across the entire façade.

In the earliest styles, such as Georgian, porches were relatively rare and, if applied at all, provided only minimal shelter. Later in the 19<sup>th</sup> century, the full veranda became popular, often with a bell-cast roof and a sloping ceiling to allow heat to rise. This type of veranda is seen, with slight variations, on Gothic Revival, Italianate, Second Empire, and Regency architecture. By the turn of the new century, and the Edwardian era, heavier, more massive columned verandas became popular, a trend that lasted well into the 20<sup>th</sup> century.

Porches and verandas have a significant impact on the function and character of buildings in the District.

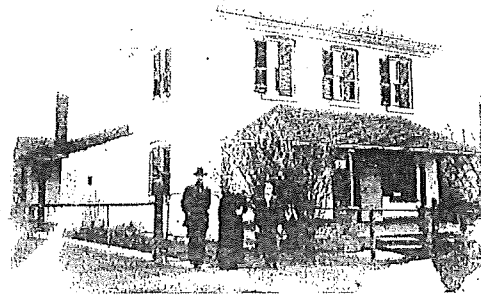

25 Colborne Street Georgian

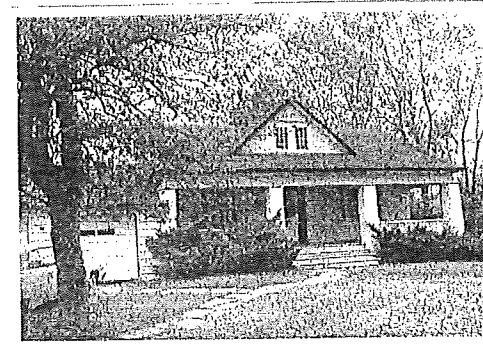

17 Eliza Street: Bungalow (demolished)



16 John Street: Victorian (porch demolished)

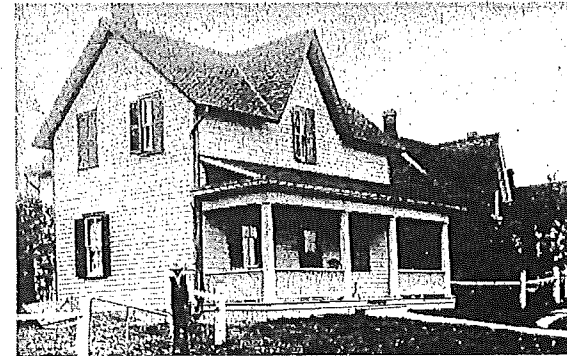

14 John Street: Victorian with later classical porch

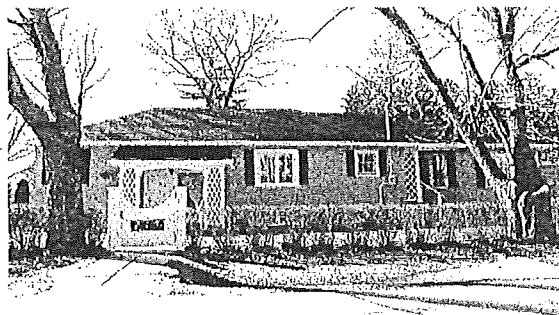

90 John Street: reproduction Regency

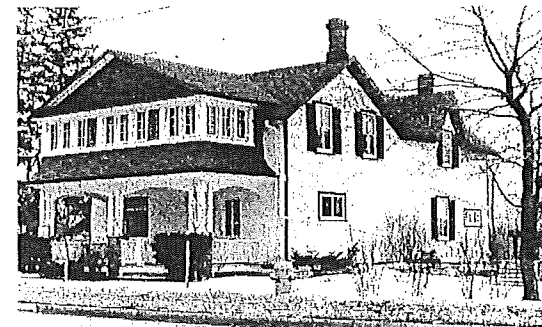

104 John Street: later Queen Anne Revival porch

## 9.4 New Buildings

### 9.4.2.34 Architectural Details: Porches and Verandas cont'd

The drawings opposite illustrate porches and verandas which, although often popular in modern construction, should be avoided since they do not reflect the character of the District, or the building design.

#### Guidelines

1. Traditional porches and verandas are encouraged as features of new construction in the District.
2. When designing new buildings, attention should be given to ensuring that the design of porches is compatible with the particular style of the building and the overall character of the street and District.
3. Non-traditional porches are not to be used.
4. Front yard decks are not supported.

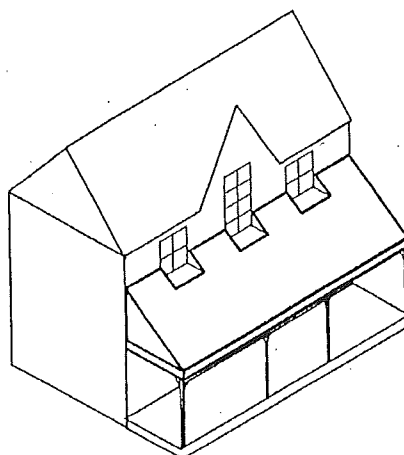

Overly heavy porch, cut into windows over narrow metal columns

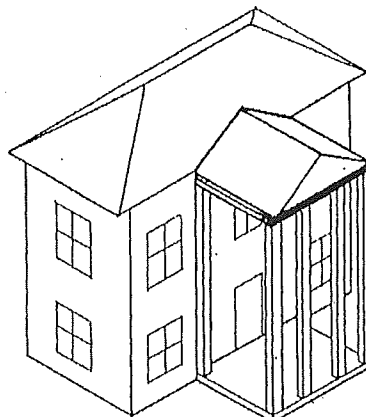

Greek Revival columned porch

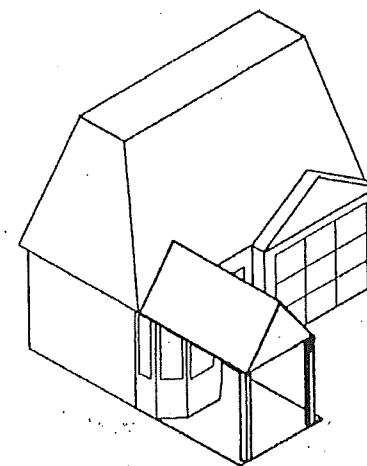

Car-port type porch

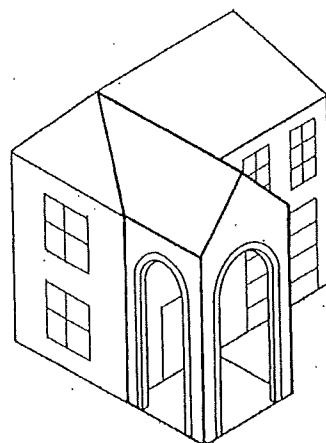

Enclave and Spanish porches

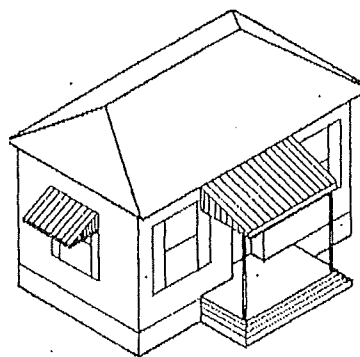

Metal awnings

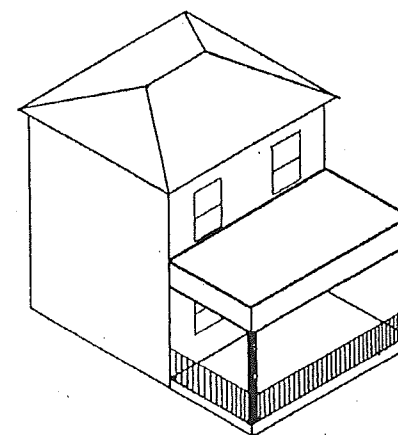

Overly heavy flat porch and wrought iron supports

**Porches illustrated are to be avoided**

## 9.4 New Buildings

### 9.4.2.35 Paint Colours

One of the most important and simple ways of integrating a new building into a heritage area is through the use of traditional local heritage paint colours.

Generally, paint colours in the rural community of Thornhill have tended to be the more reserved, and readily available, pale natural tones favoured by Andrew Jackson Downing. By the turn of the century, while pale neutral tints continued to be popular, a wider variety of colours became available.

Most paint manufacturers have produced heritage paint colour brochures which can be used to select appropriate colours for the Heritage District.

#### Guidelines

1. Select paint colours appropriate to the period and style of the building.
2. Section 9.2.4.7 of this Plan provides information on typical historic Thornhill paint colours.

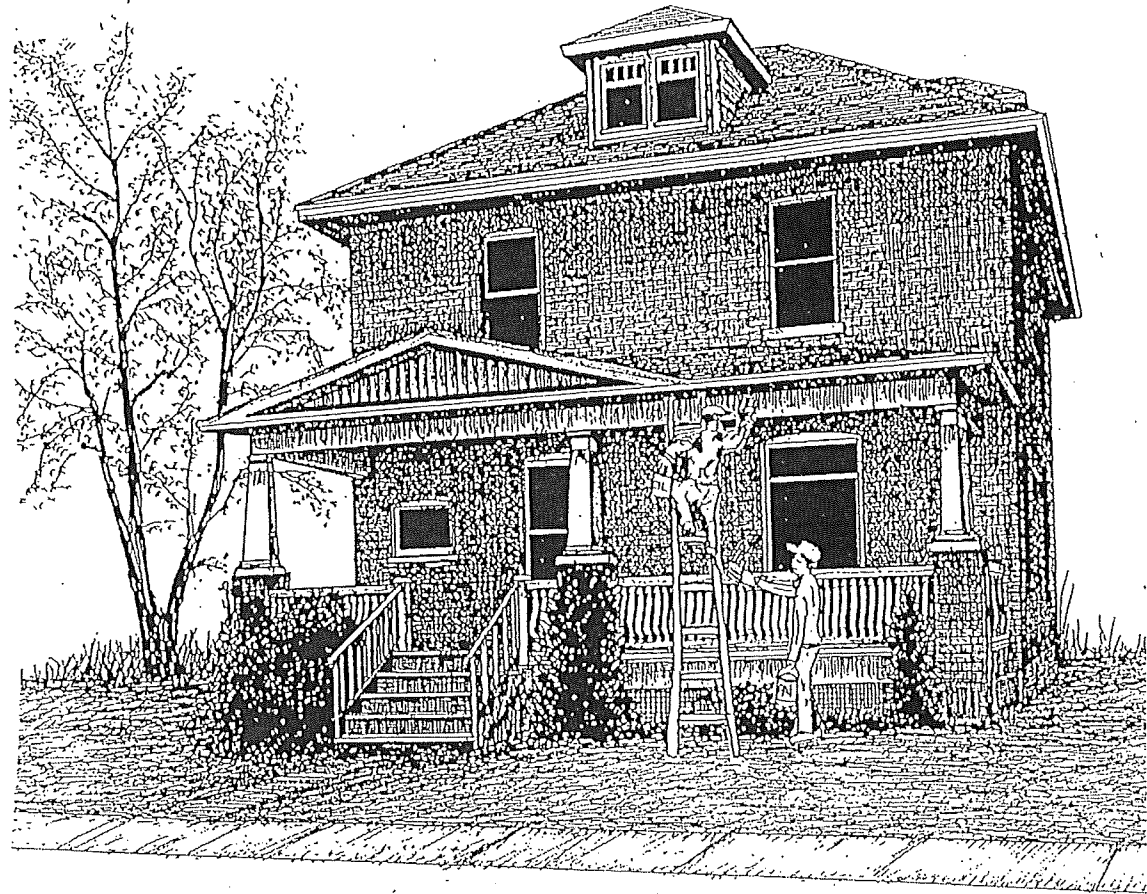

## 9.4 New Buildings

---

### 9.4.2.36 Utility and Service Equipment

Utility and service equipment should not be readily visible, especially on the front or flankage façades.

#### Guidelines

1. Service hardware such as utility meters, cable television, satellite dishes and telephone connection boxes should be visually integrated into the building design. Projecting architectural elements such as porches and bays can be configured to help conceal these services when they are proposed for the front of the building.
2. Commercial mechanical elements such as dryer vents, heat reclamation vents, furnace and water heater exhausts, gas fireplace exhausts, and kitchen exhausts which cannot be screened should not be placed on the front or flankage walls of the building.
3. Ground-mounted electrical and mechanical hardware such as heat pumps, transformers, and air conditioning units should also not be located on the front or flankage walls of the building, or should be screened in an appropriate manner.
4. Window-mounted air conditioning units should not be installed on visible elevations.
5. Noise sources should be placed away from habitable areas and operable windows

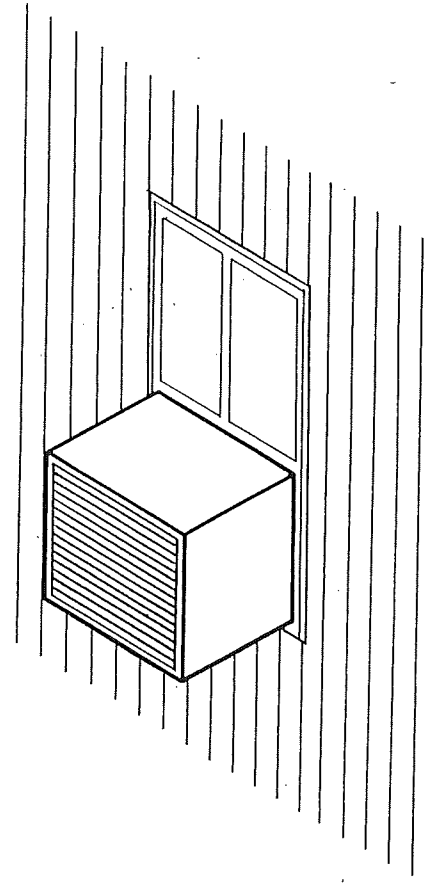

Air conditioning units should not be installed on visible elevations.

## 9.4 New Buildings

### 9.4.2.37 Garages and Ancillary Buildings- General

Since Thornhill was a rural village until relatively recent times, there are a number of historic urban barns, drive sheds, carriage houses, and stables. While their function has been adapted to suit the automobile, these features enhance the village context and are important contributors to the character of the District.

When proposing new construction, the best approach to integrating a garage into the heritage area is to reflect the design, materials, and positioning of the historic outbuildings in the village.

Traditionally, outbuildings in Thornhill were of a simple, vernacular design, primarily constructed out of wood (board-and-batten, barn board, vertical tongue-and-groove, and narrow horizontal clapboard) and were often set at the back of the lot, and not visible from the street.

The most visible element of an outbuilding is often the door. Special attention should be made to ensure that this is compatible with the Heritage District context.

#### Guidelines

1. Outbuildings and garages should have a traditional design and positioning.
2. Brick garages tend to contribute to an overly heavy appearance and should be avoided.
3. Garages should be lower in profile than the principle building and complementary in design and colour.
4. Windows and doors should be compatible with the District character.
5. The use of traditional materials and products such as wood windows and sidings, is always preferred.
6. Non-traditional materials and products (vinyl, aluminium, cement board) in historical configurations and profiles that provide the appearance of traditional materials may be used. Consultation with staff will be required.

*Double-hung windows  
with real muntin bars*

*Irregular form reduces  
perceived mass*

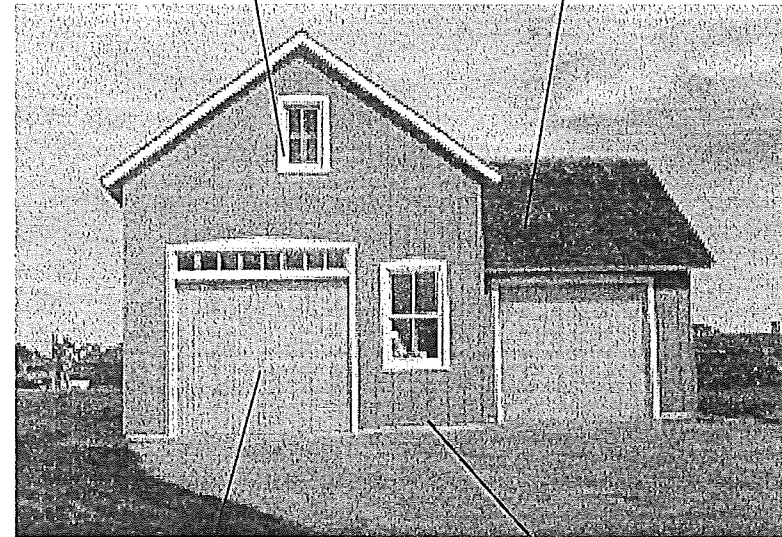

*Simple, vertical wood doors*

*Traditional wood siding*

A good example of a rear ancillary building



## 9.4 New Buildings

### 9.4.2.38 Garage Placement

The garage should not be the principal feature of a dwelling in the District. This can be achieved by a compatible design of the garage itself, as well as the position of the garage relative to the house.

Historically, garages and outbuildings in the District were located to the rear or side of the main building. Modern suburban developments have absorbed the garage into the front of the house, dominating the façade and creating a streetscape that is friendly to cars but not people.

#### Guidelines

1. Garages are to be located to the rear or at the side towards the rear of a building, so that the house, not the garage, is the focal point. Below grade garages are not supported.
2. Detached garages are recommended. Attached garages should be located on the rear façade or recessed from the front façade.

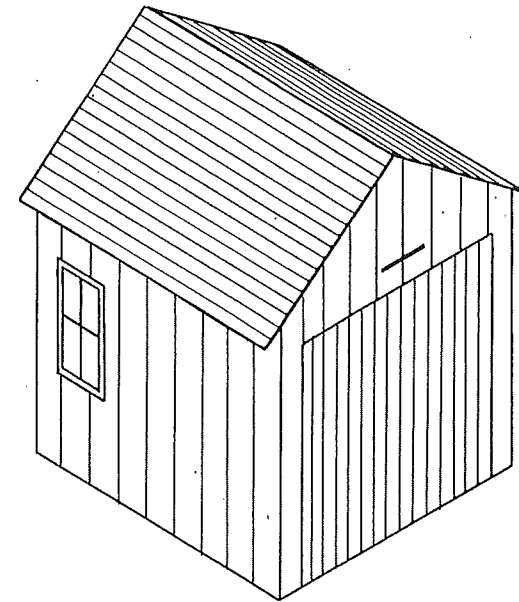

Typical rear garage design

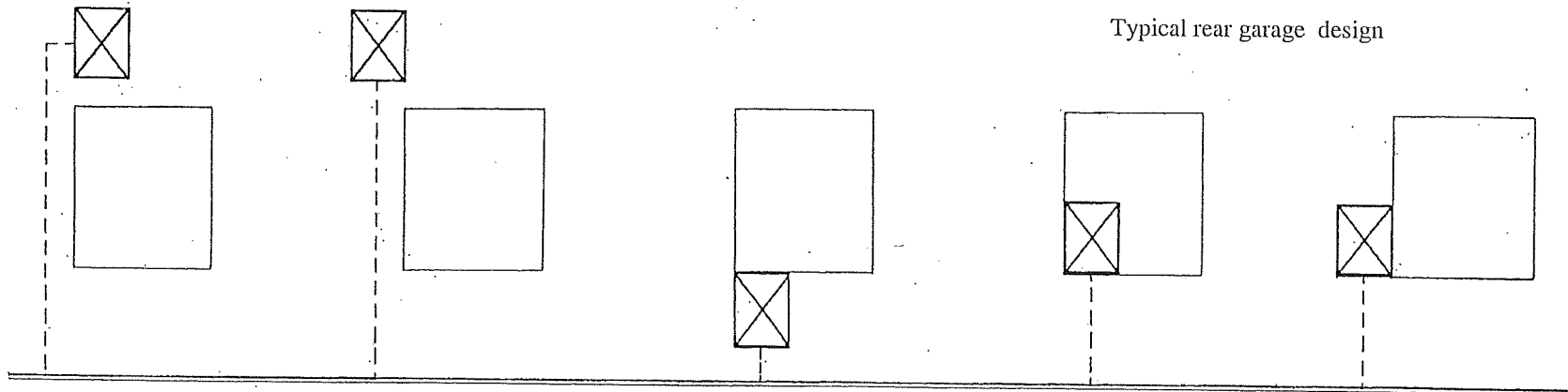

Appropriate: Rear

Appropriate: Rear side

Not Appropriate:  
Front, projecting

Not Appropriate:  
Front, flush

Not Appropriate:  
Front, no setback

## 9.4 New Buildings

### 9.4.2.39 Garage Door Design

When designing new garages in the District, the clarity and simplicity of historic frame urban barns and drive sheds should be reflected in the new construction.

Modern suburban garage doors tend to be constructed in overly elaborate designs and with materials that are not consistent with the character of the Heritage District and should be avoided.

#### Guidelines

1. New garage doors should reflect simple historic doors in a form that is consistent with the historic vernacular architecture of Thornhill.
2. Appropriate garage doors include the vertical tongue-and-groove roll-up or swing door, either with or without windows, or for less conspicuous locations simple, unarticulated wood doors may also be used.
3. Modern suburban stock, panelled garage doors are not supported.
4. Wood is preferred, but modern materials in historical configurations may also be used.

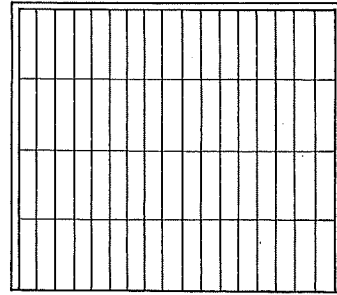

**Appropriate:** historic style vertical wood

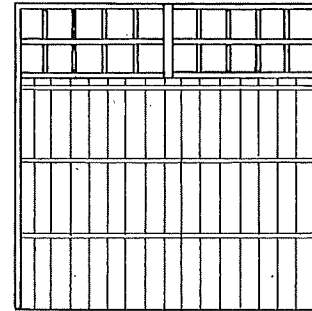

**Appropriate:** vertical wood with windows

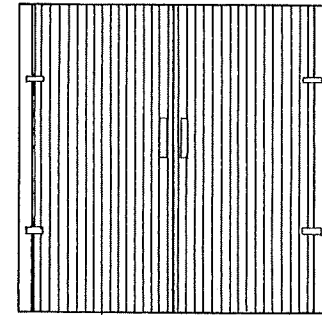

**Appropriate:** traditional swing doors

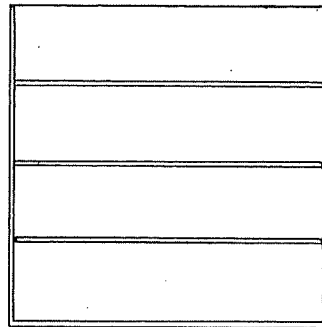

**Appropriate:** simple unarticulated door

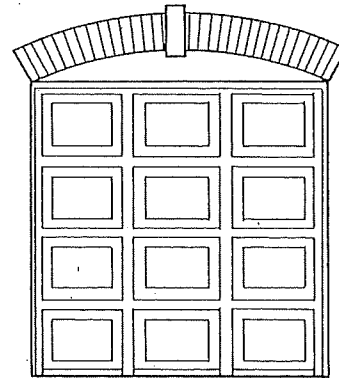

**Not Appropriate:** overly elaborate door

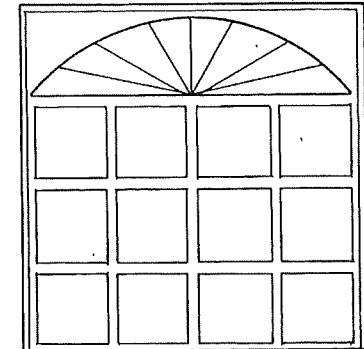

**Not Appropriate:** overly elaborate door and inappropriate window

## 9.4 New Buildings

---

### 9.4.2.39 Garage Door Design cont'd

One of the most successful examples of a new garage door in the heritage area is the vertical tongue-and-groove wood door. If properly manufactured, these doors present an appearance that resembles a carriage house door, yet is sufficiently unarticulated that it does not stand out on the façade of a building.

A traditional-looking vertical wood roll-up garage door can be attained through affixing vertical wood strips (often tongue-and-groove) to a plain garage door and using a tool to cut along the fold lines.

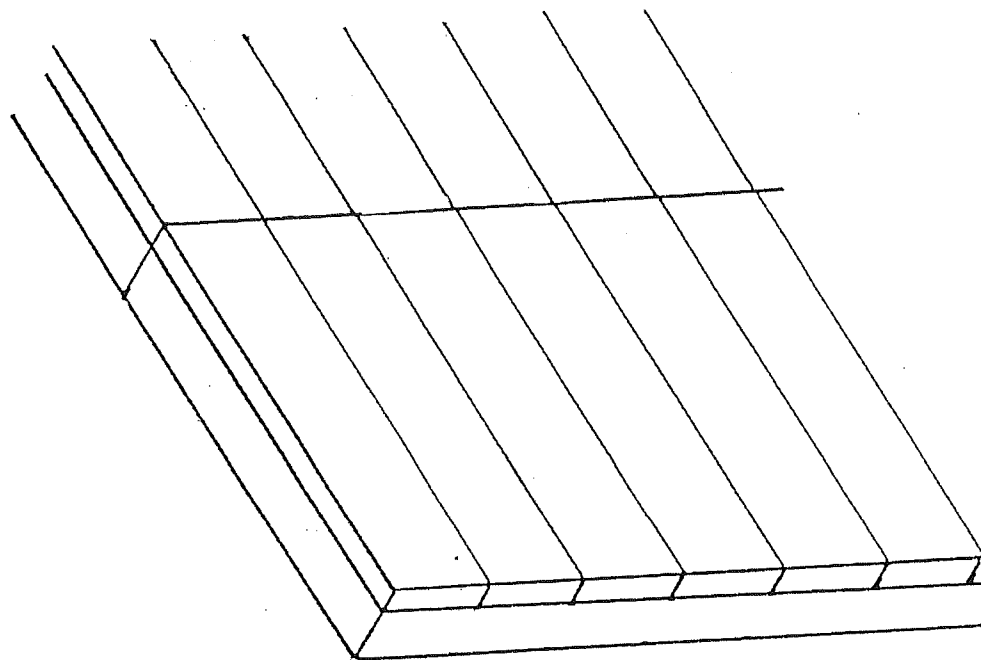

**Appropriate:** Vertical wood applied to conventional fold-up door, and cut

## 9.4 New Buildings

---

### 9.4.3 Yonge Street Commercial

The guidelines in this section generally reflect the vision for Yonge Street as depicted in the *Thornhill Yonge Street Study, 2005 – A Framework for Renewal, Reinvestment and Community Building* that was endorsed and amended by Council in April 2006.

The Thornhill Yonge Street Corridor Area is intended to become a vibrant, mixed use area. It is to be developed as a higher order transit corridor. Intensification and redevelopment will be promoted, at key locations within the corridor, in order to bring vitality to the area, to promote residential, commercial and employment growth, support transit use and enhance the urban design quality of the corridor by using redevelopment opportunities to repair existing gaps in the street wall and provide for rear yard, rather than front yard parking.

At the same time, the Thornhill Yonge Street Corridor Area overlaps part of the Thornhill Heritage Conservation District, and while intensification opportunities exist within the Heritage Conservation District, proposals must be very carefully conceived to ensure that the resulting development is compatible with and enhances the heritage character of the area.

The vision for the Thornhill Yonge Street Corridor Area is characterized by:

- a) a vibrant and mixed use main street;
- b) a predominance of at grade commercial/retail uses along Yonge Street;
- c) an attractive, high quality, pedestrian friendly, transit supportive streetscape;

- d) differing scales of development including transit supportive intensification and smaller scale infill projects to complement existing heritage assets and adjacent residential neighbourhoods;
- e) protection for, and enhancement of heritage resources and their environs;
- f) new public parks and plazas and enhanced connections to the surrounding open space system; and,
- g) organized access and parking to the rear of commercial, mixed use properties.

In addition to the guidelines in this document (which primarily originate from the Thornhill Yonge Street Study), all new development within this commercial area is subject to the general land use policies and urban design policies of the Thornhill Yonge Street Corridor section of the Thornhill Secondary Plan and is to be consistent with the provisions of the Council amended Thornhill Yonge Street Study.

## 9.4 New Buildings

---

### 9.4.3.1 Built Form Vision

The objective of the proposed built form for the Yonge Street commercial corridor is to enable the development and insertion of more intense forms of development within the context of existing heritage and complementary buildings without overwhelming valuable heritage resources. The proposed built form vision is sympathetic to the traditional smaller lot development patterns that characterize the original village and adopts a development strategy to subdivide and humanize the massing of large redevelopment sites to reflect a collection and hierarchy of composite building elements. To achieve this, new development on large redevelopment parcels should reflect a linked series of pavilion type buildings, some with greater importance than others, adding distinctive and interesting built form expression. This will help avoid the development of bland uniform building treatments or facades along the full length of a redevelopment site.

### 9.4.3.2 Location and Setbacks

New buildings should be set back to create an enhanced public streetscape realm. When new development is proposed adjacent to heritage buildings, special care must be taken to ensure that the views to the heritage resource are protected.

#### Guidelines

1. Buildings should be sited to address: 1) corner or intersection locations, 2) to occupy the primary street frontage, and 3) to occupy street frontage on the secondary/local street.
2. Buildings should be oriented towards public streets to clearly define the public realm, create a consistent street wall and create an attractive retail and commercial environment for pedestrians.

3. The segment or component of the new building adjacent to heritage buildings should align with the building face of the heritage building.
4. A side yard setback of 4 -6 metres should be achieved to emphasize the importance and prominence of the heritage building anchors or pavilions and should allow greater visibility from the road. The side yard may be used for pedestrian or vehicular access to the rear of the property.
5. Buildings fronting on Yonge Street should occupy a minimum of 70% of the frontage along the property line and buildings on secondary or local streets should occupy a minimum of 50% of the frontage along the property line.
6. To achieve an enhanced streetscape, a 1.8 m minimum setback from the edge of the public right of way is required for all properties fronting onto Yonge Street and all secondary streets. This will create a minimum 7 metre public realm from curb edge to building face. The additional 1.8 metre streetscape zone will be implemented by development proponents in a manner consistent with the streetscape improvement program.
7. Setback for development on local streets should be generally consistent with the setbacks of existing development.

## 9.4 New Buildings

### 9.4.3.3 Architectural Style

Traditional commercial areas in Ontario encompass a wide variety of historic architectural styles ranging from Georgian to Edwardian in composition.

#### Guidelines

1. New development should be products of their own time, but should be compatible with the basic tenets and styles of traditional historical commercial architecture typically found in an older Ontario downtown setting.
2. Buildings should be articulated to express a building base with traditional storefronts, a mid section and a top or cornice.
3. A consistent approach to design detail for the chosen style should be used for all building elements.
4. It is important to recognize that the overwhelming characteristic regarding style in Thornhill was its simplicity. Overly elaborate styles and others not generally compatible with a local village context should be avoided.



This photograph of Main Street in Cobourg shows a recent infill building in the foreground, with original 19<sup>th</sup>-century buildings beyond.

The low-sloped end-gable roof was common from around 1840 to 1860, with the attic floor used as unheated warehouse space for the shop below. Dormers, to provide light in the attic, are visible on the historic buildings to the left of the lamp post.

This style of commercial building, which dates from the same period as Thornhill's earliest surviving houses, is an appropriate model for Yonge Street redevelopment.

## 9.4 New Buildings

---

### 9.4.3.4 Building Form – Directional Emphasis and Massing

Building organization and massing is important to avoid the development of bland uniform building treatments.

#### Guidelines

1. Building massing should reflect a linked series of pavilion type buildings defined by recessed connector building segments. This variety in setback will create certain buildings that have greater emphasis and is somewhat in keeping with the character of a village which would have had independent buildings with sideyards
2. The recessed connector building segments should be set back from the mandatory streetscape setback an additional 1.5 to 3.0 m and will provide an area of refuge for private landscape enhancements as well as street furniture.
3. The recessed connector building segments should generally occupy 6-15 metres of street frontage.
4. Long, homogenous facades are to be avoided.
5. Mid block pavilion building segments should generally occupy 15-20 metres of the street frontage whereas corner pavilion segments should occupy more frontage (25 -30 metres)
6. Pedestrian “through building” connections from Yonge Street to rear commercial parking areas are desirable especially for any development exceeding 50 metres of continuous building frontage.
7. Massing should step down to respond to and respect adjacent heritage buildings.

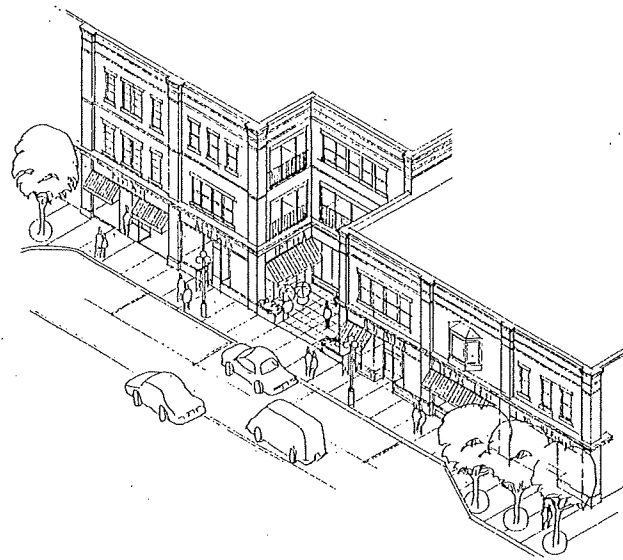

## 9.4 New Buildings

### 9.4.3.5 Building Form - Height

Height is a very sensitive issue given that the commercial properties are located within a heritage conservation district, and adjacent to heritage buildings and nearby low density residential.

#### Guidelines

1. (reserved)
2. (reserved)
3. The height of new buildings adjacent to heritage buildings should transition down to one storey above the height of the heritage building.
4. Away from the Yonge Street frontage, building heights should transition from the maximum height to the general heights of surrounding residential fabric.





## 9.4 New Buildings

### 9.4.3.6 Building Elements

Proposed new buildings should have three distinct elements: the base, the mid section and the top or cornice.

#### Guidelines

##### Building Base

1. The commercial ground floor should represent a traditional storefront treatment and should reflect a greater height than typically found in new commercial plazas. A minimum height of 4 metres is suggested.
2. Substantial glazing for retail window display would be appropriate (approximately 75% glazing)
3. The height of window and door articulation on the commercial ground floor should respond to the enhanced ground floor to ceiling height.
4. A high quality of commercial window and "storefront" design is recommended.
5. Entrances to commercial units should front onto the public streets. Corner building entrances are also encouraged.
6. Entrances should be easily identifiable and be flush with the public sidewalk.
7. The top of the building base should be marked with a storefront cornice and sign band which may include a change of material, exhibiting relief along the building frontage. The sign band may be incorporated into the cornice feature.



A recent project on Lakeshore Drive in Port Credit uses historic Ontario downtowns as its model. The buildings have an identifiable storefront "base", a two-storey middle, and a cornice at the top.

The storefront uses a similar system, with a base, a large display window as the middle, and a front-lit signband above. The storefront as a whole is framed with pilasters and a cornice.

## 9.4 New Buildings

---

### 9.4.3.6 Building Elements cont'd—

8. Weather protection in the form of traditional shaped window awnings (in materials that do not resemble plastic) are encouraged and will add interest along the street. Awnings should be configured with breaks at each vertical pier or articulated vertical element to avoid uniformity and bland application. Projected concrete or metal canopies are not permitted.
9. Based on the design, a single or consistent building material may be appropriate for both the base and the building mid section above. In some cases, a material change may be appropriate.
10. In some situations, it may be appropriate to express the building base and cornice feature to the second storey (i.e. major entrance feature)
11. In some situations, it may be appropriate to integrate a vehicular connection (such as an arched ground floor passage way) into the building base.

#### Building Mid Section

1. The building mid section should exhibit a distinctive and regular pattern of vertical relief or articulation along the street frontage from the building base cornice to the building top cornice. A 6 to 8 metre interval of vertical articulation is suggested to add visual interest. Flat buildings on a single plane are not generally supported.
2. The horizontal and vertical alignment of windows should generally be consistent while creating variation and interest along the façade. Window styles may vary between building "Pavilions".
3. Additional architectural detail may be appropriate for corner pavilion locations (i.e. special window articulation, horizontal relief).

4. Projected balconies are not permitted on corner pavilions, mid block or end pavilion building segments. Projected balconies are permitted along recessed connector building segments only but not along the Yonge Street frontage. These balconies are to be expressed as an integrated building design element. The use of concrete balcony projections is not permitted.

#### Building Top or Cornice

1. A distinctive building top roof feature or cornice element (0.6-1.0 metre) should be used at the top of the building
2. Cornice features should exhibit relief and project beyond the mid building segment.
3. Roof structures and features appropriate to the architectural design of the building are supported

## 9.4 New Buildings

### 9.4.3.7 Storefront Entry Design

Traditional storefront entry design generally consists of large divided glass windows on either side of a central, recessed entry. The display windows remain prominent while the recessed entry calls attention to the doorway. This is one of the most important rhythms of a traditional commercial area.

#### Guidelines

1. The storefront entry features should include: base panels, display windows, entry doors, transom windows, piers or pilasters, awnings and cornices.
2. The key vertical storefront parts (such as entries, doors, piers and pilasters) should align with similar parts in the upper façade.
3. The storefront should be aligned with neighbouring storefront features on the street, especially in terms of height.
4. Generally, an entry should not be set back a distance greater than 25% of the storefront width.

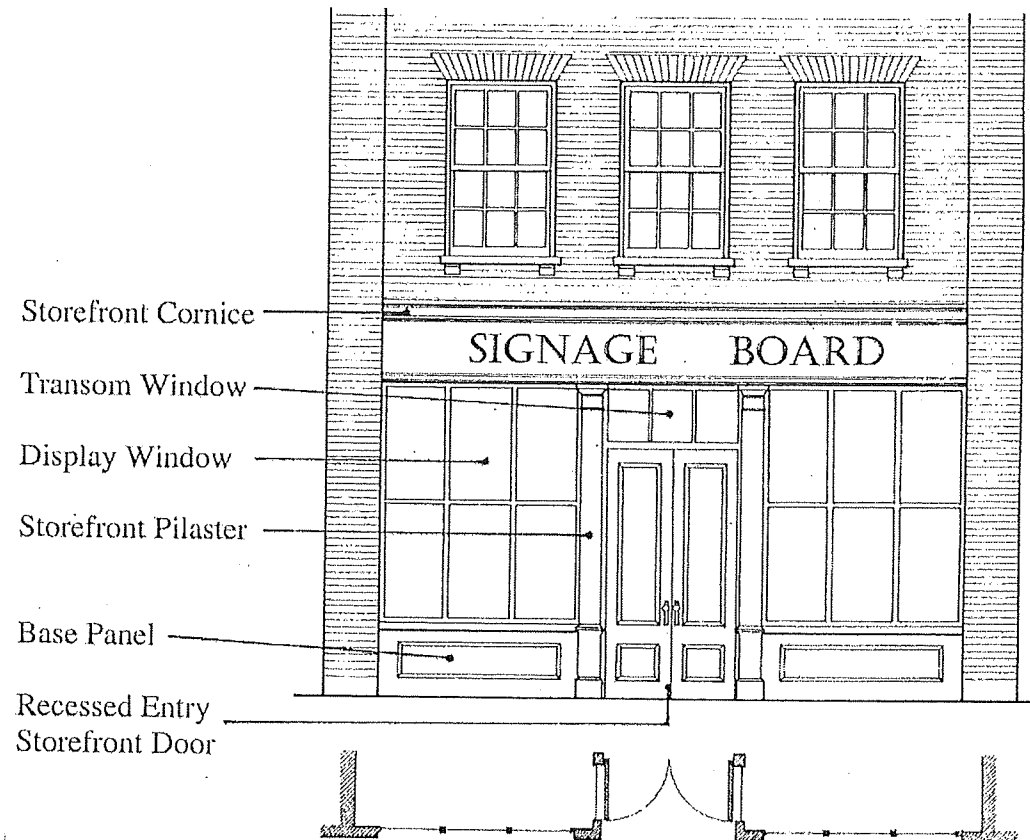

## 9.4 New Buildings

### 9.4.3.8 Windows and Doors

Windows and doors should be traditional in appearance.

#### Guidelines

1. All new mid-rise development should have windows fronting onto the street.
2. The windows on the upper levels should be consistent with the overall chosen architectural style of the building. Non traditional window shapes are not appropriate.
3. As a general principle, windows should be taller than their width (2:1 ratio).
4. Upper windows should reflect windows found on traditional downtown buildings. The use of divided windows with externally perceivable muntin bars is encouraged.
5. All windows should have a sill and a lintel.
6. The use coloured windows is not supported.
7. An appropriate traditional commercial style of door should be used (i.e. paired  $\frac{3}{4}$  glazed doors, partially glazed door).
8. Secondary doors should be different than storefront doors, but still be complementary to the storefront.
9. Windows and doors made from modern materials in historical configurations and profiles that visually give the appearance of a traditional wood window may be used. Consultation with staff will be required.

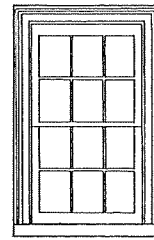

**6/6 Double Hung:**  
Square Headed

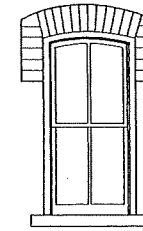

**2/2 Double Hung:**  
Segmental Arched

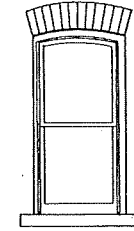

**1/1 Double Hung:**  
Segmental Arched

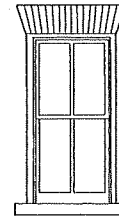

**2/2 Double Hung:**

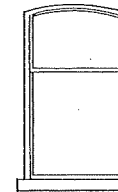

**1/1 Transom Window**

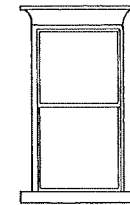

**1/1 Double Hung:**

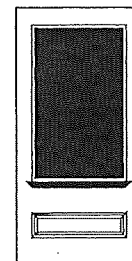

**$\frac{3}{4}$  Glazed Door**

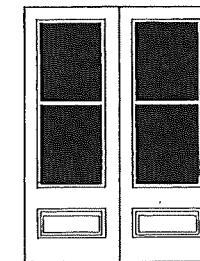

**Paired  $\frac{3}{4}$  Glazed Door**

Examples of Traditional Doors and Windows

## 9.4 New Buildings

---

### 9.4.3.9 Cladding Materials

The use of appropriate materials on new commercial development can help ensure that it is complementary to the character of the heritage conservation district

#### Guidelines

1. Materials should be consistent with the chosen architectural style of the building
2. Materials for new commercial construction should be sympathetic to materials found in the heritage conservation district.
3. The use of brick is encouraged for building mid sections. The use of wood, stucco and non-traditional siding products (in historical configurations and profiles) may be considered depending on the design, height and massing of the building.
4. The use of mirrored walls is not supported
5. The use of wood in conjunction with the traditional storefront features is desirable. Other materials in historical configurations and profile that provide the appearance of wood or are complementary to the storefront may be used.

### 9.4.3.10 Mechanical Equipment

Mechanical equipment and related infrastructure should strive not to be readily visible.

#### Guidelines

1. Rooftop mechanical equipment, transformer vaults, heat pumps and other forms of mechanical equipment should be considered in design of the building.
2. These elements should be designed or screened to reduce their visual impact on the subject building, the streetscape and neighbouring properties, as well as ensure that noise and servicing does not impact neighbouring properties.

### 9.4.3.11 Loading, Garbage and Storage

Loading, garbage and storage areas should strive not to be readily visible.

#### Guidelines

1. Loading, storage and other service areas should not be visible from any public street. Screening in the form of fencing or landscaping should be provided for these areas in order to reduce their visual impact.
2. Garbage receptacles and storage should be provided within the building.